

Revision to the SUDAS Traffic Signal Standards – Phase 2

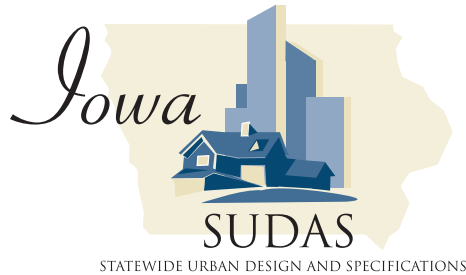

Final Report
May 2012



IOWA STATE UNIVERSITY
Institute for Transportation

Sponsored by
Iowa Highway Research Board
(IHRB Project TR-629)
Iowa Department of Transportation
(InTrans Project 11-394)

About SUDAS

The Iowa Statewide Urban Design and Specifications (SUDAS) Corporation develops and maintains Iowa's manuals for urban public works improvements, including the SUDAS Design Manual and the SUDAS Standard Specifications.

Disclaimer Notice

The contents of this report reflect the views of the authors, who are responsible for the facts and the accuracy of the information presented herein. The opinions, findings and conclusions expressed in this publication are those of the authors and not necessarily those of the sponsors.

The sponsors assume no liability for the contents or use of the information contained in this document. This report does not constitute a standard, specification, or regulation.

The sponsors do not endorse products or manufacturers. Trademarks or manufacturers' names appear in this report only because they are considered essential to the objective of the document.

Non-Discrimination Statement

Iowa State University does not discriminate on the basis of race, color, age, religion, national origin, sexual orientation, gender identity, sex, marital status, disability, or status as a U.S. veteran. Inquiries can be directed to the Director of Equal Opportunity and Diversity, (515) 294-7612.

Iowa Department of Transportation Statements

Federal and state laws prohibit employment and/or public accommodation discrimination on the basis of age, color, creed, disability, gender identity, national origin, pregnancy, race, religion, sex, sexual orientation or veteran's status. If you believe you have been discriminated against, please contact the Iowa Civil Rights Commission at 800-457-4416 or Iowa Department of Transportation's affirmative action officer. If you need accommodations because of a disability to access the Iowa Department of Transportation's services, contact the agency's affirmative action officer at 800-262-0003.

The preparation of this document was financed in part through funds provided by the Iowa Department of Transportation through its "Agreement for the Management of Research Conducted by Iowa State University for the Iowa Department of Transportation" and its amendments.

The opinions, findings, and conclusions expressed in this publication are those of the authors and not necessarily those of the Iowa Department of Transportation.

Technical Report Documentation Page

1. Report No. IHRB Project TR-629	2. Government Accession No.	3. Recipient's Catalog No.	
4. Title and Subtitle Revision to the SUDAS Traffic Signal Standards – Phase 2		5. Report Date May 2012	
		6. Performing Organization Code	
7. Author(s) Neal Hawkins, Paul Wiegand, and Beth Richards		8. Performing Organization Report No. InTrans Project 11-394	
9. Performing Organization Name and Address Institute for Transportation Iowa State University 2711 South Loop Drive, Suite 4700 Ames, IA 50010-8664		10. Work Unit No. (TRAIS)	
		11. Contract or Grant No.	
12. Sponsoring Organization Name and Address Iowa Highway Research Board Iowa Department of Transportation 800 Lincoln Way Ames, IA 50010		13. Type of Report and Period Covered Final Report	
		14. Sponsoring Agency Code	
15. Supplementary Notes Visit www.intrans.iastate.edu for color pdfs of this and other research reports.			
16. Abstract <p>This report provides a summary of the updates to the traffic signal content within the Iowa Statewide Urban Design and Specifications (SUDAS) Design Manual Chapter 13 and Standard Specifications Division 8. Major focal points included pole footing design, cabinets and controllers, monitoring systems, communications systems, and figure updates.</p> <p>This work was completed through a project task force with a variety of participants (contractors, Iowa Department of Transportation, city traffic engineers, consultant, vendors, and University research and support staff).</p>			
17. Key Words fiber optic systems—pole footing design—signal cabinets—signal controllers— traffic signal communications equipment—traffic signal figures		18. Distribution Statement No restrictions.	
19. Security Classification (of this report) Unclassified.	20. Security Classification (of this page) Unclassified.	21. No. of Pages 83	22. Price NA

REVISIONS TO THE SUDAS TRAFFIC SIGNAL STANDARDS: PHASE 2

Final Report
May 2012

Principal Investigator

Neal Hawkins, PE
Director, Center for Transportation Research and Education
Institute for Transportation, Iowa State University

Co-Principal Investigator

Paul Wiegand, PE
Director, Statewide Urban Design and Specifications
Institute for Transportation, Iowa State University

Authors

Neal Hawkins, Paul Wiegand, and Beth Richards

Sponsored by
the Iowa Highway Research Board
(IHRB Project TR-629)

Preparation of this report was financed in part
through funds provided by the Iowa Department of Transportation
through its research management agreement with the
Institute for Transportation
(InTrans Project 11-394)

A report from
Institute for Transportation
Iowa State University
2711 South Loop Drive, Suite 4700
Ames, IA 50010-8664
Phone: 515-294-8103
Fax: 515-294-0467
www.intrans.iastate.edu

TABLE OF CONTENTS

ACKNOWLEDGMENTS	vii
PROJECT BACKGROUND	1
PROJECT ACTIVITIES.....	1
SUDAS MANUAL UPDATES.....	2
Design Manual	2
Specifications Manual.....	3
IMPLEMENTATION ACTIVITIES.....	4
FUTURE RESEARCH	4
APPENDIX A. SUDAS DEIGN MANUAL CHAPTER 13, SECTIONS 13D-1 (DESIGN CONSIDERATIONS) AND 13E-1 (SPECIFICATIONS INFORMATION).....	A-1
APPENDIX B. SUDAS SPECIFICATIONS SECTION 8010 (TRAFFIC SIGNALS)	B-1
APPENDIX C. MAST ARM POLE FOOTING DESIGN SUMMARY	C-1

ACKNOWLEDGMENTS

The authors would like to thank the Iowa Highway Research Board (IHRB) and Iowa Department of Transportation (DOT) for sponsoring this research. The authors would also like to thank the following individuals and groups for their respective involvement.

Committee

- Tim Crouch, Iowa DOT
- Jennifer Dakovich, City of Des Moines, Iowa
- Ron Johnsen, Iowa Signal and Electric
- Michael Jorgensen, Iowa DOT
- David Ness, City of Dubuque, Iowa
- Tom Reis, Iowa DOT
- Brian Wilham, Shive-Hattery, Inc.

Subcontractor

The authors wish to thank Snyder & Associates, Inc., especially Tony Boes, Mark Perington, and Steve Klocke, for their expertise and work in development of the detailed information and the revised figures.

Industry

- Jim Conner, Traffic and Transportation Products Limited (TATPL)
- Dan Dillavou, The Waldinger Corporation
- Dan Fuchs, Brown Traffic Products, Inc.
- Louis Glover, General Traffic Controls, Inc.
- Joe Henkels, Baker Electric, Inc.
- Doug Ripley, Traffic Control Corporation

Special thanks to Beth Richards for taking the information provided and placing it in the appropriate format for the Iowa Statewide Urban Design and Specifications (SUDAS) Design and Specification Manuals.

PROJECT BACKGROUND

Iowa Highway Research Board (IHRB) project TR-546 provided an update to the traffic signal content within the Iowa Statewide Urban Design and Specifications (SUDAS) Design Manual Chapter 13 and Standard Specifications Division 8. This work was completed through a project task force with a variety of participants (contractors, Iowa Department of Transportation, city traffic engineers, consultant, vendors, and University research and support staff).

TR-546 included a major revision to the SUDAS traffic signal specifications. New content was added and all proprietary references were eliminated. Major revisions to the SUDAS traffic signal design guidelines were also developed.

Instead of printing various parts of the Manual on Uniform Traffic Control Devices (MUTCD), the electronic version of the revised design chapter provides hyperlinks to the MUTCD as well as to other state Department of Transportation (DOT) resources that provide aid to the designer. The changes developed through TR-546 were implemented in the SUDAS manuals for the 2011 editions.

Due to time and funding constraints for Phase 1 (TR-546), the project task force identified additional work to complete in Phase 2 (TR-629). This project was approved by the IHRB with the following work tasks included:

1. Update the existing SUDAS traffic signal figures
2. Conduct a structural review of footing steel and concrete capacities and standards, and incorporate this information into the SUDAS Design Manual
3. Develop and include non-proprietary, performance-based controller and cabinet specifications
4. Develop and include non-proprietary fiber optic cable, modem, and communications specifications
5. Develop and include non-proprietary video monitoring/camera specifications

PROJECT ACTIVITIES

The initial activities included forming an overall project technical advisory committee (TAC) made up of representatives from the Iowa DOT, the subcontractor on the project (Snyder & Associates, Inc.), and the Institute for Transportation (InTrans) team. In addition, another committee was formed that included traffic engineers from cities across the state, a traffic signal contractor, and consultants who are involved in traffic signal design. A third group of cities, contractors, and suppliers were also used for input on the draft documents.

A number of opportunities were provided for input from designers, contractors, and suppliers. In March 2011, the TAC met to establish the study processes and schedule. The existing figures and specifications were sent to the committee for initial input also in March 2011.

Other city traffic engineering professionals in Iowa were also included in the initial input stage, even though they were not a part of the formal committee:

- Jim Dickinson, West Des Moines
- Mohammad Elahi, Waterloo
- Mark Franz, Council Bluffs
- Ron Knoche, Iowa City
- Scott Logan, Sioux City
- Tom Peterson, Cedar Rapids
- Damion Pregitzer, Ames
- Gary Statz, Davenport

Using the input received, the InTrans team and Snyder & Associates, Inc. developed the draft specification changes. The 90 percent draft was developed and presented to the committee for review in August 2011.

Based on additional input received, modifications were made and the draft changes to the manuals were sent to the committee for comment on October 10, 2011. On November 29, 2011, a committee meeting was held at InTrans to make decisions as to what the final draft language should include.

After changes were made based on the input from the committee, the final draft was sent to the other engineers listed above and to various contractors and suppliers. In addition, SUDAS staff initiated the review of the draft at the six SUDAS district committee meetings in February 2012.

Following input received in February, the final changes were made and the documents were resubmitted during the April SUDAS district committee meetings for final recommendation to the SUDAS Board of Directors. The SUDAS district committees unanimously recommended adoption by the SUDAS Board of Directors and the board took action on May 11, 2012 to approve the revised traffic signal specifications, figures, and design guidance.

SUDAS MANUAL UPDATES

Design Manual

The complete version of the updated sections within SUDAS Design Manual Chapter 13 is shown in Appendix A. Three general areas within the Design Manual were updated. The first was one of the most important elements of the research project.

As the SUDAS manuals evolved from the central Iowa area, the parameters used in the design of the footings for traffic signal poles were lost. To bring some level of certainty to the engineers using the footing design, a new analysis was conducted using Brohm's method for lateral resistance (moment/shear design) per the American Association of State Highway and Traffic

Officials (AASHTO) Standard Specifications for Structural Supports for Highway Signs, Luminaires, and Traffic Signals, 2009 and the Federal Highway Administration (FHWA) Drilled Shafts: Construction Procedures and LRFD [Load and Resistance Factor Design] Design Methods (2010) for torsion design. The summary of the analysis process is included in Appendix C.

The soil strength, wind speed, and gust factor, frost depth, water table depth, and pole loading parameters were provided. Knowledge of these factors will allow designers to compare their situations with the parameters used in the SUDAS design.

As a result of this analysis, the depth of the footings and the size of the required reinforcement increased over the previous SUDAS guidance. One of the committee representatives was concerned that the calculation may be too conservative and that the footing cost would increase significantly. Based on that concern, the InTrans team sent out a questionnaire to the cities across the state to determine what size of footings they were using. All of the respondents matched the new requirements for depth and steel that were being proposed.

The second area dealt with accessible pedestrian signals. The Americans with Disabilities Act (ADA) and the MUTCD require the designer to evaluate the need to install accessible pedestrian signals. The additional guidance provided reminds designers that each evaluation needs to address the following topics:

- Potential demand for pedestrian signals
- Requests for accessible signals by persons with visual disabilities
- Traffic volumes when pedestrians are present, including low volumes or high right-turn-on-red volumes
- Complexity of the signal phasing, such as split phasing or protected turn phases
- Complexity of the intersection geometry

If the accessible pedestrian signal is warranted, the designer is now provided basic information regarding the ADA requirements.

The third area included updating the new requirements for cabinets and controllers, fiber optic cables, and cameras used for communications.

Specifications Manual

The completed specifications section is included as Appendix B. The updates included the following:

- Revised all of the figures. Obsolete information was deleted and new information was included. The appropriate information for contractors was condensed to seven figures, as opposed to the previous 20 figures.

- Updated the submittals subsection to allow for electronic submittal of the schedule of unit prices, the material and equipment list, and shop drawings, if allowed by the jurisdiction.
- Added non-proprietary specifications for fiber optic cable and accessories.
- Clarified that reinforcing steel for footings does not need to be epoxy coated.
- Added non-proprietary specifications for traffic signal cabinets and controllers complying with NEMA TS-1 and TS-2 standards. Type 170 equipment is used only by the City of Des Moines and they agreed to write their own supplemental specifications to meet their needs.
- Added non-proprietary specifications for traffic camera monitoring systems.
- Added product information and installation specifications, in addition to a figure, for a new pedestrian push button post that would be placed to meet ADA accessibility guidelines when the traffic signal pole placement would cause non-compliance.

IMPLEMENTATION ACTIVITIES

The findings of this research will be shared through incorporation into the SUDAS manuals, as well as through presentations at a variety of professional, municipal, and national group presentations. This information will be disseminated and available for use by all agencies that use the SUDAS manuals.

In addition, discussions will be initiated with the Iowa DOT staff with the intention of making the specifications and figures joint documents between the Iowa DOT and SUDAS. The joint documents will not only enhance the overall project timeline for traffic signal construction activities due to engineer and contractor familiarity, but will also save costs through the use of consistent equipment and materials.

FUTURE RESEARCH

Due to the relatively recent requirements to evaluate the need for accessible pedestrian signals, there are no standard specifications available for the required equipment. The next step will be to develop equipment and installation requirements for the various elements needed for accessible pedestrian signals.

In addition, further research is anticipated in the area of footing design criteria in contrast to risk based on experienced failure.

APPENDIX A. SUDAS DEIGN MANUAL CHAPTER 13, SECTIONS 13D-1 (DESIGN CONSIDERATIONS) AND 13E-1 (SPECIFICATIONS INFORMATION)

Design Considerations

In addition to basic MUTCD requirements, the safe and efficient operation of a signalized intersection requires careful attention and balance of a number of design parameters. This section provides some reference resources for the traffic signal designer in consideration of these features.

A. Geometrics

The geometrics of an intersection are a critical consideration given the potential impact on intersection safety and performance. Geometrics directly impact sight distance, vehicle separation, operations, and capacity. As a result, intersection geometrics should always be considered whether dealing with existing, reconstructed, or new signalized intersections.

References are made to [Signalized Intersections: Informational Guide](#), FHWA-HRT-04-091, August 2004, which provides a single, comprehensive document with methods for evaluating the safety and operations of signalized intersections and tools to remedy deficiencies. The treatments in this guide range from low-cost measures such as improvements to signal timing and signage, to high-cost measures such as intersection reconstruction or grade separation. While some treatments apply only to higher volume intersections, much of this guide is applicable to signalized intersections of all volume levels.

1. **Basic Geometric Considerations:** The geometric design section of the [Signalized Intersections: Informational Guide](#) provides the following comments:

Geometric design of a signalized intersection involves the functional layout of travel lanes, curb ramps, crosswalks, bike lanes, and transit stops in both the horizontal and vertical dimensions. Geometric design has a profound influence on roadway safety; it shapes road user expectations and defines how to proceed through an intersection where many conflicts exist.

In addition to safety, geometric design influences the operational performance for all road users. Minimizing impedances, eliminating the need for lane changes and merge maneuvers, and minimizing the required distance to traverse an intersection all help improve the operational efficiency of an intersection.

The needs of all possible road users must be considered to achieve optimal safety and operational levels at an intersection. At times, design objectives may conflict between road user groups; the practitioner must carefully examine the needs of each user, identify the tradeoffs associated with each element of geometric design, and make decisions with all road user groups in mind.

The [Geometric Design](#) section addresses the following design topics to be considered when designing traffic signal controlled intersections:

- [3.1 Channelization](#)
- [3.2 Number of intersection approaches](#)
- [3.3 Intersection angle](#)
- [3.4 Horizontal and vertical alignment](#)
- [3.5 Corner radius and curb ramp design](#)

- [3.6 Sight distance](#)
- [3.7 Pedestrian facilities](#)
- [3.8 Bicycle facilities](#)

2. Additional Sight-distance Considerations:

- a. Sight distance is a safety requirement that impacts intersection geometrics as fundamental as horizontal and vertical alignments. It is a design requirement that is discussed in detail as it relates to the visibility of traffic signal indications in the MUTCD. In addition to the sight distance requirements of the MUTCD, the AASHTO “Policy on Geometric Design of Highways and Streets 2001” states that drivers of the first stopped vehicles on all approaches should have adequate sight distance to view one another. It also states that left turning vehicles should have adequate sight distance to select gaps in oncoming traffic and complete turning maneuvers. This requires consideration of offset left turn lanes to provide adequate left turn sight distance. If right turns are allowed on a red signal indication, the appropriate departure sight triangle should be provided. Finally, the policy states that the appropriate departure sight triangles should be provided for left and right turning vehicles on the minor approach for two-way flashing operations. Two-way flashing operations are flashing yellow for the major street and flashing red for the minor street. See Chapter 9 - Intersections in the AASHTO “Policy on Geometric Design of Highways and Streets 2001” for additional sight distance information.
- b. One sight distance issue that deserves additional consideration is the sight triangle and the sight obstructions found within it. Certain obstructions are obvious like structures near the street. Other obstructions are not always obvious or are installed after the traffic signal is designed and constructed. These obstructions seem to blend into the background. They are obstructions like entrance monuments, special street name signs, business signs, and landscape vegetation that may not be a problem initially but become a problem as the plants reach maturity. Finally, be aware of the signal cabinet size and location including the height of the footing or cabinet riser so it does not become a sight obstruction.
- c. Sight distance requirements are less restrictive at signalized intersections as drivers are required by law to obey the signal indications; however, there are instances when drivers do not obey traffic signals. A traffic signal should be designed to exceed minimum sight distance requirements when possible. Drivers are taught to drive defensively and providing additional sight distance will only aid drivers in collision avoidance.

3. Turn Lanes:

- a. Traffic volumes, turning movement counts, and crash history are used to complete intersection capacity and accident analyses. The results of the analyses determine the need for turn lanes, the number of turn lanes, and the length of the turn lanes. The turn lane information is used to properly design the geometrics of signalized intersection approaches.
- b. Turn lane capacity issues often create safety problems. Left or right turning vehicle queues blocking through traffic create increased potential for rear-end accidents. Sideswipe potential also increases as traffic attempts to maneuver out of defacto turn lanes or around left turn queues blocking through lanes. High volumes of turning vehicles combined with high volumes of opposing vehicles significantly reduce the number and size of available gaps needed to complete turning maneuvers increasing the potential for right angle collisions. As a result, properly designed turn lanes improve safety as well as capacity.

- c. Determining turn lane design details when upgrading existing signalized intersections in largely developed areas is relatively straight forward. Capacity problems are recognized through evidence obtained from capacity analyses, visual inspections, and/or citizen comments. Capacity analyses and visual inspections of peak hour traffic often reveal long queues that do not clear after multiple signal cycles. Heavy turning volumes and a lack of turn lanes on multilane facilities often result in shared lanes acting as defacto turn lanes. If turn lanes exist, traffic volumes may exceed the capacity of the turn lanes resulting in vehicle queues spilling out of the turn lanes and into the through lanes.
- d. Determining turn lane design details when constructing new signalized intersections in undeveloped or under developed areas experiencing significant growth is a challenge. In many cases, there is no visual evidence of existing capacity or safety problems. The challenge is judging future traffic patterns and the extent of the traffic growth over a given time period, usually twenty years, with no guarantees as to the type, extent, and rate of development. Judgment is improved with information and the information is obtained from capacity analyses that examine existing and proposed development, existing traffic volume data, and future traffic volume data derived from land use maps and the ITE Trip Generation Manuals. This information combined with traffic growth rates obtained from developed areas with similar land use characteristics and engineering judgment are used to arrive at an intersection design that will support existing traffic volumes as well as future growth.
- e. Past experience has helped to formulate several design guidelines used to initially determine the number of lanes needed at an intersection. These guidelines are planning level guidelines and should be confirmed with the results of the operational analysis methods discussed in the Operations section of this chapter. The guidelines can be found in Chapter 10 of the Highway Capacity Manual 2000 (HCM 2000) and are summarized as follows:
- 1) **Exclusive Left Turn Lanes:**
 - A single exclusive left turn lane should be considered when the minimum left turn volume is 100 veh/hr.
 - Dual exclusive left turn lanes should be considered when the minimum left turn volume is 300 veh/hr.
 - 2) **Exclusive Right Turn Lanes:**
 - An exclusive right turn lane should be considered when the right turn volume exceeds 300 veh/hr and the adjacent mainline volume exceeds 300 veh/hr/ln.
 - 3) **Number of Lanes:**
 - Enough lanes should be provided to prevent the total volume of the approach from exceeding 450 veh/h/ln.
- f. Past experience has also helped to formulate several design guidelines used to initially determine turn lane lengths needed at intersections. Like the guidelines used to determine the number of lanes, the guidelines used to determine turn lane lengths are planning level guidelines and should be confirmed with the results of an operational analysis. Also remember that the lengths discussed here are the actual storage lengths and do not include taper lengths. Taper requirements are discussed in several sources including the Chapter 5 of this manual, the Iowa DOT Design Manual, and the AASHTO Policy on Geometric Design of Highways and Streets. The guidelines are as follows:
- Enough storage length should be provided to equal one foot for each vehicle per hour (vph) turning during the peak hour in the horizon year. For example, 250 vph turning during the peak hour in the horizon year would require a 250 foot turn lane.

- Storage length can also be computed using the following equation:

$$\text{Storage Length} = (h / s) (v + g) (p)$$

h = horizon year peak hour volume (vph)

s = number of signal cycles per hour

A signal cycle is typically 60 to 120 seconds. Engineering judgment is used to select the cycle length or lengths to use in the equation.

v = average vehicle length

The average vehicle length often used is 20 feet.

g = average gap between vehicles

The average vehicle gap often used is 5 feet.

p = probability factor

The probability factor is based on the Poisson distribution and associated with the probability that enough length is provided to store all vehicles.

Probability factor (p)	Probability of Storing All Vehicles
1.50	0.90
1.75	0.95
1.85	0.98
2.00	> 0.98

A paper written by the Transportation Research Institute at Oregon State University suggests modifying the average vehicle length plus gap ($v + g$) based on the percentage of trucks using the turn lane. The paper suggests modifying $v + g$ as follows:

Percent trucks	$v + g$
< 2%	25'
5 %	27'
10 %	29'

The initial storage length for dual left turn lanes can be found by dividing the storage length found from one of the two methods discussed above by 1.8.

Example:

$h = 250$ vph

$s = 100$ s/cycle

$3600 \text{ s/hr} / 100 \text{ s/cycle} = 36$ cycles/hr

5% trucks

$v + g = 27'$

$p = 1.85$ (95% probability)

Single lane storage length = $(250 / 36) (27) (1.75)$

Single lane storage length = 328': Say 325'

Determining turn lane length also requires some additional considerations. One consideration is the length of the queues in the through lanes. If the turn lanes are not long enough, through lane queues may prevent turning vehicles from entering the turn lanes leaving the turn lanes

nearly empty until the through lane queues begin clearing. This issue could be addressed with lagging lefts but lagging lefts require additional considerations to prevent left turn traps and an operational analysis to determine optimal signal phasing and timing. If through lane queues block the turn lanes, the turn lanes could be lengthened beyond the through lane queues. However, the additional length needed may not be practical.

Another consideration is maximum turn lane length. Once a turn lane becomes too long, the signal cycle cannot serve all the traffic waiting in the turn lane reducing, if not eliminating, the benefits of the extra length. At this point, it may be more practical to add turn lanes or look at other solutions to relieve congestion. When is a turn lane too long? It is difficult to point to an exact number but in the neighborhood of 350 to 400 feet. An operational analysis will provide better evidence regarding the maximum length.

The final consideration that can impact the length of a turn lane is visibility. A turn lane that starts just beyond the crest of a vertical curve may not be visible until a vehicle is at the start of the lane. It may be practical to extend the turn lane to increase its visibility giving drivers more time to react to the lane.

- g. Lane balance should be considered when addressing lane geometrics. Left turn lanes should be opposing or offset to one another. If dual left turn lanes are required on one approach, dual left turn lanes or a wide median should be installed on the opposing approach to promote lane balance. Through lanes should be located so they align with one another as the intersection is traversed. Creating a lane shift through an intersection creates driver confusion.

4. **Agency Geometric Considerations:** The Mn/DOT [Traffic Engineering Manual](#) (Section 9-6.00 Traffic Signal Design) provides a good identification of major issues for design consideration and serves as an example of agency specific criteria. Since this is a PDF document, Sections 9-6.02 through 9-6.05 are provided below:

Intersection geometry is an important element of traffic signal design. The design of traffic signal system hardware and operation of the traffic signal system should be preceded by a thorough evaluation and, if necessary, geometric improvement of the existing intersection. Mn/DOT Section 9-6.03 notes the following geometric elements should be considered:

- a. Pavement width should be adequate for anticipated traffic movements and future capacity requirements. Highway capacity analysis should be performed to get a better understanding of the capacity of the intersection.
- b. If appropriate islands should be designed and constructed so that the driver has adequate reaction distance to them and they are large enough to install a standard signal foundation. Existing shoulders should always be carried through the intersection; this will usually provide enough reaction distance to the island. However, turning radii should be checked to ensure enough setback for comfortable turns.
- c. Turn lanes must provide adequate storage in order to prevent turning traffic from interfering with other traffic movements and thus causing capacity breakdown.
- d. When a median width is more than 30 feet between opposing through lanes, special signal design considerations are necessary (See MN MUTCD, Section 4H). Extremely wide medians confuse drivers on the crossing street, prevent them from being comfortable with opposing traffic, and cause them to lose track of their path. Wide medians also cause capacity restrictions because more time is needed for vehicle movements and clearances

- through the intersection.
- e. Sidewalks should be constructed as close to the center of the corner as possible. Pedestrian crosswalks should be in line with the sidewalk and as close to the intersection as practical.
 - f. Alignment changes within the intersection should be avoided. Vehicles approaching the intersection should be directed through the intersection. Vertical alignments approaching signals must allow for proper signal visibility.
 - g. Driveways within an intersection should be signalized and accommodated by the intersection geometrics. Whenever feasible, the driveways should be located or relocated outside the limits of the intersection.
 - h. The size of corner radii is an important consideration. Excessively large corner radii may obscure intersection limits and create a hazard for bicycles and pedestrians, while very small radii may create a hazard for motorists. Corner radii at signalized intersections should not be less than 20 feet nor more than 60 feet. A turning radius guide for 58 foot vehicles should be used to determine proper corner radii. At intersections where bus routes are located, corner radii should be analyzed giving due consideration to bus maneuvers.
 - i. It may be necessary to relocate utilities such as manholes, catch basins, fire hydrants, overhead power and telephone lines and power poles, to obtain adequate geometrics for signalization. The existence of these utilities must not get in the way of adequate geometrics.
 - j. Pedestrian curb ramps should be considered in accordance with Chapter 12 if sidewalks are present.
 - k. Handhole spacing should be based on the following factors:
 - Location of junction points within the signal system
 - Physical features, such as driveways, utilities, etc.
 - Cable pull length based on size of cable and diameter of conduit

B. Operational Characteristics

The behavior of the traffic at an intersection is another highly important element of signal design. Mn/DOT Section 9-6.03 notes the following elements should be considered:

1. Existing 15 minute vehicle volumes, by vehicle class, and pedestrian volumes, are the most basic operational consideration. Data used should represent intersection operation in peak periods. Saturated approaches should have an upstream count taken to determine the demand volume rather than the service volume at the intersection.
2. Intersection capacity should be determined based on the Highway Capacity Manual and other sources.
3. The vehicle approach posted speeds should be determined for the location of advance detection.
4. Adjacent land uses should be evaluated to identify activities which may conflict with intersection operation. Items that should be considered include entrances, advertising devices, and areas of high pedestrian activity (schools, manufacturing plants, shopping centers, etc.).
5. Crashes within the intersection should be studied to determine causes and possible design solutions.

6. Pedestrian volumes and school-crossing activities should be studied to determine pedestrian routes and necessary design treatments. Pedestrian movements in and around signals should be routed into the intersection crosswalks in front of vehicles stopped for the signal. Provide pedestrian refuges in medians 6 feet and wider.

C. System (Arterial) Considerations

In many cases, an individual traffic control signal must be considered as part of a system, either as one of a series of signals along a linear route, or as one signal in a grid network. Mn/DOT Section 9-6.04 notes the following elements should be considered.

System considerations in signal design should include but are not limited to the following:

1. Adjacent signals should be interconnected whenever they are less than one-half mile apart, when the travel time between adjacent signals is less than the cycle length at each signal, or when platoons leaving one intersection remain intact to the next signal.
2. Properly spaced signalized intersections greatly simplify coordination in planning new signals. Minimum spacing of one-quarter mile is recommended. Irregular signal spacing reduces the overall operational efficiency of the mainline movements and greatly complicates signal coordination.
3. Whenever possible, platoons should be kept intact to allow easier mainline coordination and minimize cross-street delay.
4. New street or roadway construction should anticipate the need for future signals and the need for handholes and conduit, particularly under the roadway.
5. Pretimed controllers are used in built-up urban environments, particularly central business districts. The streets are not excessively wide and the traffic patterns are quite predictable. In this environment, a signal cycle should contain pedestrian movements. Actuated controllers are used in suburban and rural environments. In the rural environment, the actuated controller tends to reduce the number of stops and does not cut off platoons of vehicles. In the suburban environment, the arterial streets tend to be very wide, and the volumes are usually quite high on these arterials. There are not usually many pedestrians crossing such an arterial, so an actuated controller tends to operate much more efficiently, as it is not necessary to time pedestrian intervals except when an actual demand exists.
6. Splits and offsets should be carefully estimated to determine their impact on arterial flow. A split is the relative percentage of green time allocated to each of the various phases at a single intersection. An offset is the travel time between signals, usually expressed in percent of cycle length.
7. Minimum pedestrian walk and clearance timings should be anticipated when designing coordinated signal systems.

D. Signal Design Elements

Mn/DOT Section 9-6.05 notes the following elements should be considered:

1. The most efficient operation of a signal system is attained with the fewest phases that are enough to move traffic without hazardous conflicts. Procedures exist to determine the optimum number of phases for an intersection.
2. The primary consideration in signal head placement is clear visibility. Drivers approaching an intersection shall be given a clear and unmistakable indication of their right-of-way assignment. The number and placement of signal faces shall conform to the requirements of the MUTCD. Overheads should be located as near as practicable to the line of the driver's normal view. When an overhead is to control two lanes, it should be installed over the lane line dividing the two lanes. An overhead should be used over each lane when speeds are above 40 mph. The size of lenses shall be as stated in the MUTCD. See the signal head placement charts in the Signal Design Manual. In general, vehicle signal faces should be placed and aimed to have maximum effectiveness for an approaching driver located a distance from the stop line equal to the distance traveled while reacting to the signal and bringing the vehicle to a stop at an average approach speed. Visors, shields, or visual delimiting should be used to help in directing the signal indication to the approaching traffic, and to reduce sun phantom resulting from external light entering a signal lens.
3. Vehicle detectors should be placed according to the detector spacing chart and the loop placement diagrams.
4. At locations where pedestrians are expected, provisions must be made to control pedestrian activity in and around the signalized intersection. At locations where pedestrians are expected, pedestrian indications shall be provided if minimum pedestrian crossing time exceeds minimum vehicular green time, or if any of the conditions set out in section 4E.3 of the MN MUTCD are met. Pedestrian push buttons should be installed at locations with pedestrian activity where it is not operationally efficient to provide pedestrian timing on every cycle. Pedestrian signal indications shall be mounted, positioned, and aimed so as to be in the line of pedestrians' vision, and to provide maximum visibility at the beginning of the controlled crossing.
5. If it is determined to prohibit pedestrian movement across any approach, that prohibition must be clearly visible to pedestrians by use of Standard Sign R9-3a on each side of the prohibited crosswalk. See part 4 of the MN MUTCD for further information.
6. Street lighting should normally be installed with traffic signals and flashing beacons. The luminaires are generally 250-watt high-pressure sodium vapor luminaires, mounted in the far-right quadrants of the major street. Larger intersections may require additional luminaires. Forty foot mounting heights provide even light distribution. Street lights installed on Type A signal mast-arm poles should be mounted at approximately 350 degrees clockwise from the mast arm in order to provide frontal illumination of any signs mounted on the mast arm.

Signal design must take into account the existing adjacent lighting systems and the equipment available to provide access to the luminaires for relamping and maintenance. The presence of overhead power lines must also be taken into account. These must be designed around or moved.

E. Traffic Signal Operations

The Mn/DOT [Traffic Engineering Manual](#) provides an exceptional discussion on basic traffic signal operations and design considerations. These are not reprinted within this document but these references are noted below.

- [Mn/DOT Traffic Signal Timing and Coordination Manual](#)
- [Traffic Engineering Manual](#)
 - Chapter 2. Traffic Signal Phasing and Operations
 - Chapter 3. Head Placement Charts
 - Chapter 4. Detection
- [Mn/DOT Signal & Lighting Certification Manual](#)

F. Pedestrian Considerations

1. Geometrics:

- a. Geometrics have a significant impact on pedestrian operations and safety at signalized intersections as alluded to in the previous section. Intersection skew, number of lanes, lane width, medians, islands, and curb returns all impact the distance pedestrians must travel to cross an intersection. As the distance to traverse an intersection approach increases, so does the signal timing that must be allocated to the pedestrian clearance interval. Long pedestrian clearance intervals have a negative impact on traffic capacity and operations. A pedestrian actuation will disrupt traffic signal coordination and require several cycles to bring a corridor back into coordination. However, large pedestrian volumes may dictate signal timing resulting in less than optimal conditions for vehicles. A traffic engineer must balance the priorities of vehicles and pedestrians with no calculations or answers that clearly define a solution but do provide guidance.
- b. Right turns present challenges for pedestrians. A driver of a vehicle turning right on red will be looking left for a gap in traffic. A pedestrian approaching from the right may have a walk indication. If the driver sees a gap but does not look back to the right, the pedestrian may not be seen by the driver resulting in a collision. As a result, a traffic engineer must decide whether to allow right turns on red.
- c. Right turn lanes can present additional challenges for pedestrians, especially if the returns are large and channelize traffic with an island. The islands can channelize right turning vehicles away from the traffic signal indications creating difficulties signalizing the right turn movement. Using a stop sign instead of a supplemental signal indication for the channelized right turning movement is not an option. It creates a confusing message when all movements on the approach see green indications, including right turning vehicles, until they are partially through the turning maneuver and see a stop sign. Some agencies assign the right turning vehicles a yield sign but it creates an issue protecting pedestrians. If a pedestrian push button is used at the back-of-curb and pedestrians must cross a right turn lane controlled by a yield sign, it may give pedestrians a false sense of security when crossing in front of right turning vehicles. Drivers of right turning vehicles see a yield sign and look left, away from the pedestrians stepping off the curb, for a gap in traffic. In fact, drivers of right turning vehicles would be looking even farther left due to the channelization and orientation of the vehicles making it even more difficult for drivers to see pedestrians approaching from the right. Consequently, pedestrian volume and safety are important considerations when considering and designing right turn lanes.

- d. The final geometric consideration as it relates to pedestrians is the pedestrian refuge. Right turn islands and medians often double as pedestrian refuges. If islands and medians are intended to be used as pedestrian refuges, they must be large enough to hold pedestrians and be ADA compliant. A traffic engineer must consider the likelihood that pedestrians will stop and get stranded in an island or median. On large approaches, it may be intended that pedestrians only cross a portion of the approach and stop in a median or island. As a result, a traffic engineer must decide whether to install supplemental push buttons in the right turn island or median. If islands and medians are not intended to function as pedestrian refuges, they must be located so they do not obstruct the path of pedestrians.
2. **Visibility:** Visibility is important to the safe operation of the pedestrian indications. Pedestrian indications as well as the push buttons should be easily located by pedestrians. Consider where vehicles, especially large trucks, may stop so they do not obstruct the view of the pedestrian indications. This will require careful location of median noses, stop bars, crosswalks, and the pedestrian heads. Finally, make sure there are no obstructions in the returns that may prevent drivers and pedestrians from seeing one another such as the signal cabinet or vegetation.
 3. **Special Considerations:** Circumstances often arise that require special considerations. For example, children may have difficulty understanding the meaning of pedestrian indications. Count down pedestrian heads may be easier for children to understand; therefore, have increased value in school zones. Count down pedestrian heads may also have added value on wide approaches. The flashing numbers can attract a person's eye and the numbers tell a pedestrian how much time they have to cross which has added value on very wide approaches. There may be a particular area within a city that has a high concentration of visually impaired. In this case, audible pedestrian indications may have added benefit. In many cases, some extra thought and minimal dollars can change a design from adequate to desirable.
 4. **Americans with Disabilities Act:** The Americans with Disabilities Act (ADA) addresses several design requirements relating to pedestrians. ADA addresses design requirements for items such as sidewalk ramps, truncated domes, and pedestrian push buttons. These topics are addressed in detail in several design manuals such as the MUTCD, the AASHTO Policy on Geometric Design of Highways and Streets, and Chapter 12 of this manual.
 - a. **Accessible Pedestrian Signals:** Each traffic signal project location should be evaluated to determine the need for accessible pedestrian signals, especially if the project location presents difficulties for individuals with visual disabilities. An engineering study should be completed that determines the needs for pedestrians with visual disabilities to safely cross the street. The study should consider the following factors:
 - Potential demand for accessible pedestrian signals
 - Requests for accessible pedestrian signals by individuals with visual disabilities
 - Traffic volumes when pedestrians are present, including low volumes or high right turn on red volumes
 - The complexity of the signal phasing, such as split phasing, protected turn phases, leading pedestrian intervals, and exclusive pedestrian phases
 - The complexity of the intersection geometry

If a pedestrian accessible signal is warranted, it is necessary to provide information to the pedestrian in non-visual formats. This will include audible tones and vibrotactile surfaces. Pedestrian push buttons should have locator tones for the visually impaired individual to be able to access the signal. Consistency throughout the pedestrian system is very important. Contact the Jurisdictional Engineer regarding the standards and equipment types that should be incorporated into the design of the accessible pedestrian signal system.

- b. Location of Pedestrian Push Buttons:** It is common to see a narrow grass strip between the sidewalk and pole used to mount the push buttons or to only see sidewalk on one side of a pole containing multiple push buttons. It is difficult to impossible for a person in a wheelchair to reach the push button in cases like these since it often requires the person to struggle with one wheel in the grass and one on the sidewalk. As a result, sidewalks must be paved up to the pole used to mount the push buttons and be at a reasonable slope. There should also be sidewalk on each side of a pole that has a push button. The MUTCD requires a pedestrian push button mounting height of approximately 3.5 feet above the sidewalk; keep in mind that the 3.5 feet is above the grade where the pedestrian would be when accessing the button. Often times pole footing elevations end up above grade and installing a push button based on the footing elevation and not the ground elevation where the pedestrian accesses the button results in a mounting height that is too high. Finally, consider the proximity of the push buttons to the street. If the poles used to mount the push buttons are too far from the street, pedestrians will not use the push buttons. Consider installing supplemental poles closer to the street for mounting the push buttons.

G. Driver and Pedestrian Expectations

Other traffic signal design considerations involve driver and pedestrian expectancy. A traffic engineer must look beyond the traffic signal being designed and consider the characteristics of the corridor and the attributes of the existing traffic signals along the corridor. For example, left turn phasing should be applied consistently and not switch between protected only and protected/permissive without legitimate reasons. If pedestrian signal heads are used, they should be used consistently and not sporadically where one intersection uses the heads and the next intersection relies on vehicular signal heads to guide pedestrians. Traffic signal head style, placement, and orientation should be consistent along a corridor as well as sign type, size, and location. Intersections should not randomly switch between doghouse and vertical five section heads, center of lane and lane line placement, or vertical and horizontal signal head orientation. Consistently applied design criteria improve driver and pedestrian expectations which typically promote safety and operations. However, circumstances exist that may, at times, require changes to design criteria to increase vehicle and pedestrian safety and operations.

H. Future Development and Improvements

One of the biggest traffic signal design challenges is designing a traffic signal in an area that is under developed or being redeveloped. Under these circumstances much of the data needed for design is either unknown or unstable. Land uses are often modified and business prospects continually change often having significant impacts on existing and future traffic volumes. In addition, the rate at which traffic volumes will increase is difficult to determine. In such cases, the traffic signal designer must work closely with adjacent area land use planning agencies to work towards reasonable expectations for future travel demands and overall operations. Future phases can be accommodated for within the design to significantly reduce the need to replace footing locations, adjust mast-arm lengths, or add additional functionality to the traffic signal. These simple steps can build credibility with the public and add considerable efficiency to the traffic signal design and overall engineering process.



Specifications Information

This section provides design information that complements and is organized similar to the SUDAS Specifications Section 8010, which includes:

Part 1 - General

Part 1 provides direction on general items such as submittals; substitutions; delivery, storage, and handling; scheduling and conflicts; and measurement and payment.

Part 2 - Products

Part 2 describes the products to be provided and is arranged as follows:

- 2.01 Underground
- 2.02 Detection
- 2.03 Communications
- 2.04 Cabinet and Controller
- 2.05 Poles, Heads, and Signs

Part 3 - Execution

Part 3 describes how these products should be installed and matches the arrangement described in Part 2, with the following additions:

- 3.06 Temporary Traffic Signal
- 3.07 Surface Restoration
- 3.08 Testing
- 3.09 Documentation

The information below provides selective guidance on the specifications.

A. Part 1 - General

1. **Submittals:** There are several key submittals required of the contractor following award of the project. These are described below.
 - a. **Schedule of Unit Prices:**
 - 1) **Document:** Prepared by the traffic signal designer and included within the contract documents (generally attached to the back of the traffic signal specifications).
 - 2) **Purpose:** Contracting authority approval of the unit pricing for all major traffic signal items. Establish unit pricing for change order work if needed. Used to estimate partial payments.
 - 3) **Includes:** Identification of major traffic signal items along with an estimate of quantity and units of measurement. Two additional blank columns are provided (unit price, and unit extension).
 - 4) **Contractor Action:** Within 30 days after award, the contractor is required to submit a completed schedule of unit prices to the contracting authority for engineer approval.

- 5) **Engineer Action:** Review the schedule in a timely manner. Check the appropriateness of each unit price, the accuracy of each unit extension calculation, and ensure that the grand total for all unit extensions matches the lump sum bid item for traffic signalization. Upon acceptance, sign and date the document and provide a copy to the contractor.
- b. Material and Equipment List:**
- 1) **Document:** Prepared by the traffic signal designer and included within the contract documents (generally attached to the back of the traffic signal specifications).
 - 2) **Purpose:** Contracting authority approval of the make and model numbers for all major traffic signal items.
 - 3) **Includes:** Identification of major traffic signal items along with an estimate of quantity and units of measurement. Two additional blank columns are provided (manufacturers name and each items model number).
 - 4) **Contractor Action:** Within 30 days after award, the contractor is required to submit a completed list of materials and equipment to the contracting authority for engineer approval.
 - 5) **Engineer Action:** Review the schedule in a timely manner. Check the appropriateness of each identified manufacturer and model number. Upon acceptance, sign and date the schedule and provide a copy to the contractor.
- c. Contractor Certification:**
- 1) **Document:** Prepared by the contractor on company letterhead.
 - 2) **Purpose:** Contracting authority approval of key project personnel.
 - 3) **Includes:** Name, contact information, and certification of the Level II International Municipal Signal Association (IMSA) Certified Traffic Signal Technician(s) working on the project.
 - 4) **Contractor Action:** Within 30 days after award, the contractor is required to submit the contractor certification to the contracting authority for engineer approval.
 - 5) **Engineer Action:** Review the appropriateness of the information and on acceptance, sign and date the document, and provide a copy to the contractor.
- d. Shop Drawings:**
- 1) **Document:** Prepared by the traffic signal pole supplier for the contractor.
 - 2) **Purpose:** Contracting authority approval of traffic signal poles, supports, and related hardware.
 - 3) **Includes:** Shop drawing information detailing each traffic signal pole, accompanying parts, and necessary hardware.
 - 4) **Contractor Action:** Within 30 days after award, submit shop drawings to the contracting authority for engineer approval.
 - 5) **Engineer Action:** Review the shop drawings in a timely manner. Check the appropriateness of each detail. Upon acceptance, sign and date the shop drawings and provide a copy to the contractor.
- e. Catalog Cuts:**
- 1) **Document:** Prepared by the traffic signal equipment supplier for the contractor.
 - 2) **Purpose:** Contracting authority approval of all items within the equipment and materials list as well as for supporting components.
 - 3) **Includes:** Catalog cut information detailing the make, model number, manufacturer, and specific details for all traffic signal equipment.
 - 4) **Contractor Action:** Within 30 days after award, submit catalog cuts to the contracting authority for engineer approval.

- 5) **Engineer Action:** Review the catalog cuts in a timely manner. Check the appropriateness of each item. Upon acceptance, sign and date the catalog cut documents and provide a copy to the contractor.
2. **Substitutions:** Comply with SUDAS Specifications Division 1 - General Provisions and Covenants.
3. **Delivery, Storage, and Handling:** Comply with SUDAS Specifications Division 1 - General Provisions and Covenants.
4. **Scheduling and Conflicts:** Comply with SUDAS Specifications Division 1 - General Provisions and Covenants.
5. **Special Requirements:** Comply with the current edition of the MUTCD as adopted by the Iowa DOT.
6. **Measurement and Payment:** Traffic signal work is typically bid as a lump sum item of which no measurements are made. However, partial payments to the contractor are established through measuring installed quantities and applying these quantities to the appropriate approved unit price (see Schedule of Unit Prices above).

B. Part 2 - Products

1. Underground:

- a. **Handhole:** Handholes are a critical component to traffic signal design. The standard precast concrete handhole shown in Figure 13E-1.01 is typically used at all locations except where fiber optic cables are used and adjacent to the controller cabinet.

Composite handholes can come in all shapes and sizes (see [Quazite](#) example table) and must be specified by the Engineer. These are typically made of a polymer concrete. Polymer concrete is made from selectively-graded aggregates in combination with a polymer resin system. When combined through a process of mixing, molding and curing, an extremely powerful cross-linked bond is formed. Precast polymer concrete is reinforced with fiberglass for strength and rigidity.

The designer should ensure that the contract documents clearly distinguish between handhole types, sizes, and desired locations. Handholes are typically uniquely numbered on the contract documents.

An online resource can be found through [Chapter 11](#) Handholes from (Mn/DOT's 2009 Signal & Lighting Certification Manual) which provides the designer with a photographic resource for considering handhole features and functions along with execution issues such as installation, inspection, and key points to remember.

Figure 13E-1.01: Conduit and Handholes
(SUDAS Specifications Figure 8010.103)

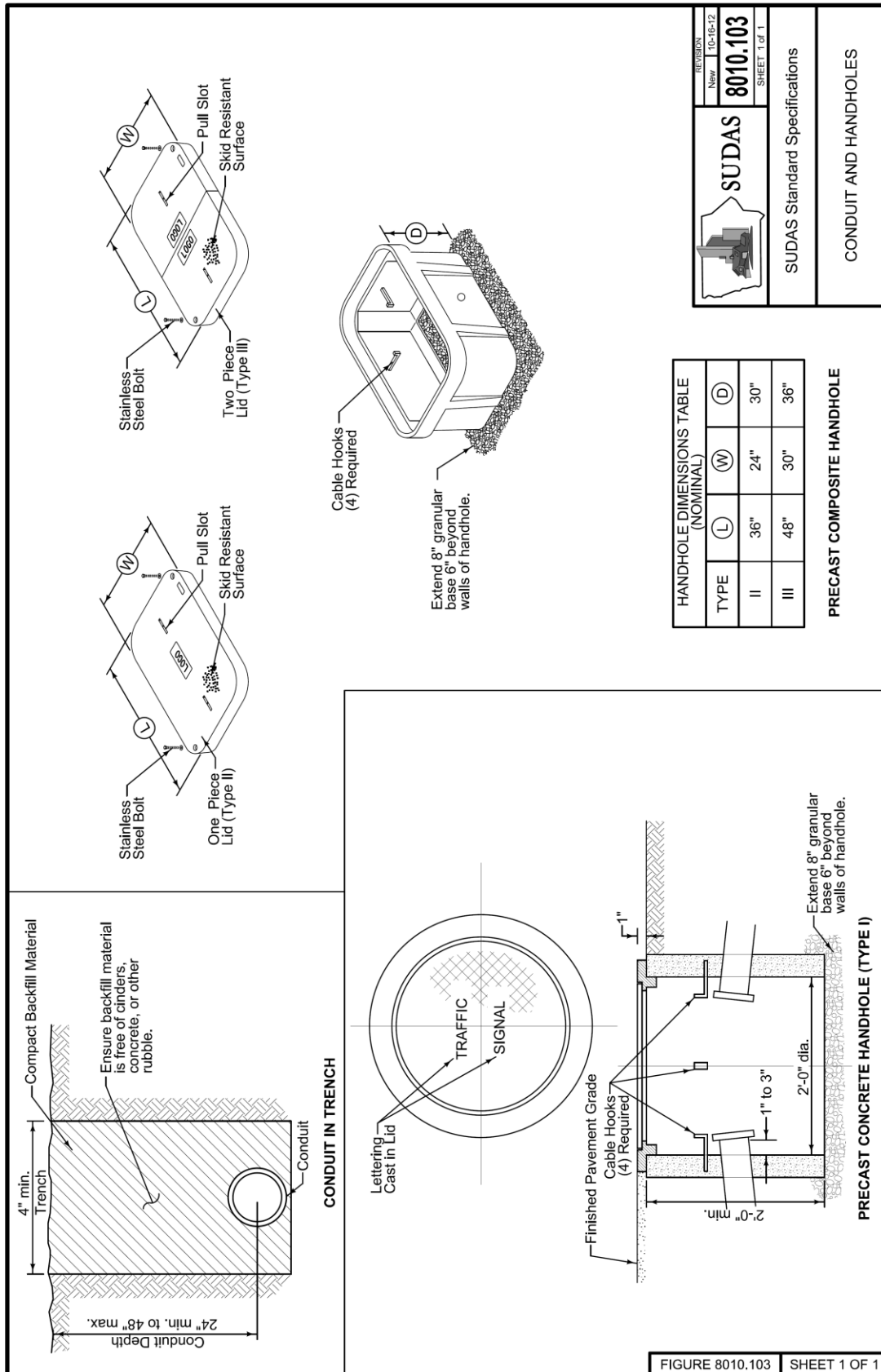

FIGURE 8010.103 SHEET 1 OF 1

- b. Conduit:** The SUDAS Specifications allow both steel and PVC plastic conduit. Steel conduit is typically used on all service risers and plastic PVC or HDPE is used at all other locations. A typical signal installation will use a variety of conduit sizes. When connecting HDPE conduit to PVC conduit, the designer should work with the Contractor to clarify the method or materials to be used.

A conduit check list from Mn/DOT [Signal Design Documents, Checklists and Worksheets](#) is noted below: The designer should ensure the following:

- Conduit size and cables listed.
- Correct symbol for in-place conduit.
- Correct symbol for proposed conduit.
- Check for conflict with in place underground utilities.
- Conduit fill less than 40% (Check).
- 3 inch RSC minimum size conduit under all public traveled roadways.
- Spare 4 inches of conduit out of controller cabinet for future use, threaded and capped.
- Conduit runs for interconnect should be as straight as possible.
- No PVC above ground (for example: bridge crossings and wood pole systems).
- All conduits except those within pads shall drain.
- Primary power shall be in a separate conduit run and separate hand holes.
- Size of bends and elbows in conduit in accordance with National Electrical Code or UL guidelines.
- If conduit is suspended under a bridge, does the distance between supports conform to code, is a hanger detail given in plan, and are expansion fittings called for?
- Conduit placed under in-place pavement does not need to be labeled (bored or pushed).

An online resource can be found through [Chapter 10](#) Conduits and Fittings (Mn/DOT's 2009 Signal & Lighting Certification Manual) that provides the designer with a photographic resource for considering conduit installation and features.

- c. Wiring and Cable:** Signalized intersections require a variety of standard wires and cables; however, the number, size, and quantity of extra conductors pulled can vary by agency. The designer should include sufficient details to ensure the clear identification of cable runs by conduit. The inspector should make sure all wires are terminated neatly and in an organized fashion. With the exception of detector lead-in wires, no splices are allowed within handholes. All plan terminology should be consistent for example:
- Cable symbols correct (3/C #12, 2/C #14, 3/C #20 all different, for example).
 - Ped indications on different phases shall have separate 3/C #12 cables.
 - Separate 2/C #14 for each detector.
 - Provide spares for future expansion of system, if necessary, and label them.

An online resource can be found through [Chapter 14](#) Wiring (Mn/DOT's 2009 Signal & Lighting Certification Manual) which provides the designer with a photographic resource for labeling and training wires (very Mn/DOT specific though).

- d. Footings:** Signalized intersections require footings for all poles, controller pads, and other service cabinets such as fiber optic hubs or electrical service panels. Controller footing details are included for NEMA controller cabinets as shown in Figure 13E-1.02. The designer should ensure that the plans reflect any desired future use spare conduit stubs out of the footing.

Figure 13E-1.02: Cabinet Footing Details
(SUDAS Specifications Figure 8010.101)

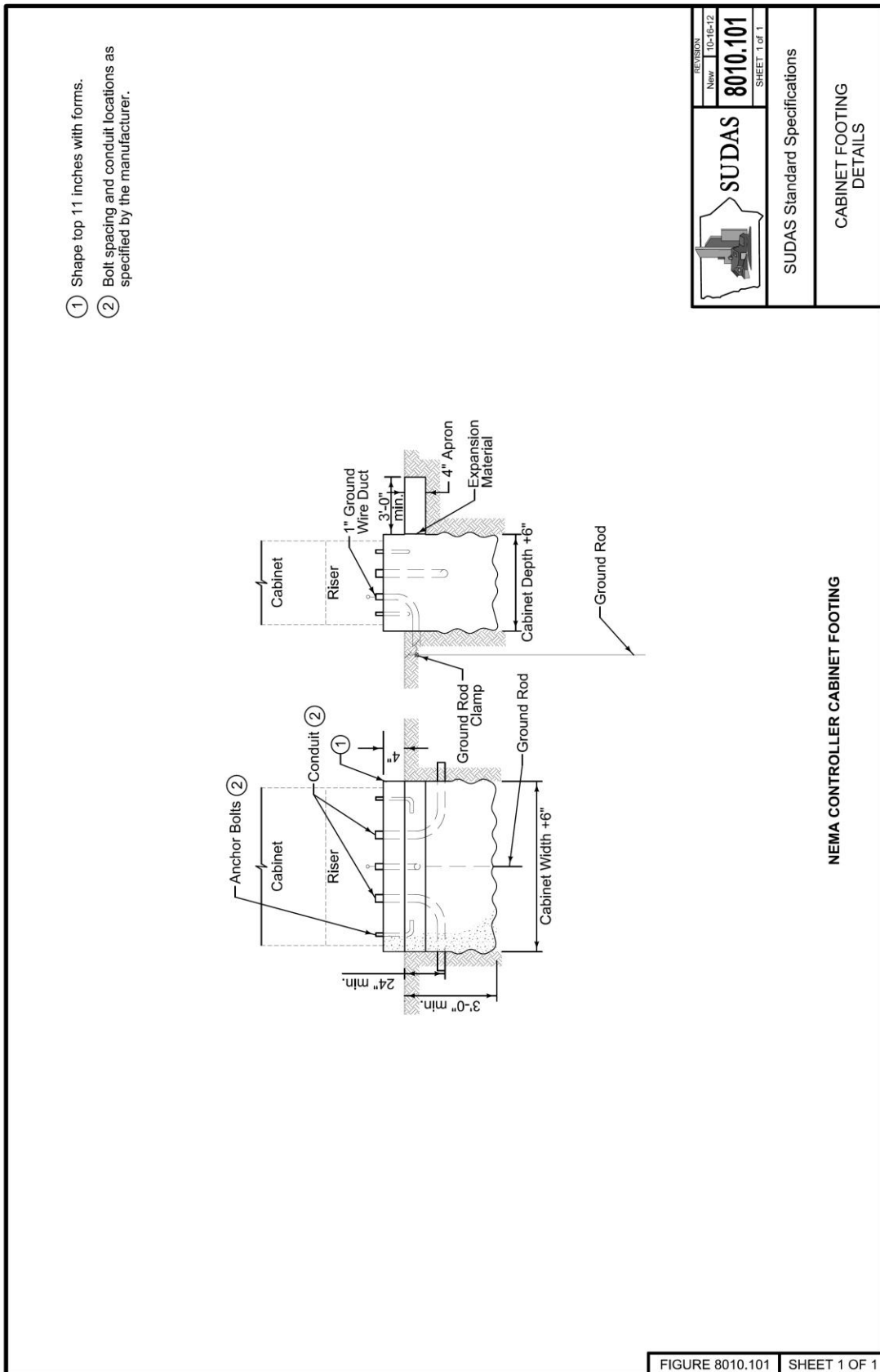

Footing size and depths vary according to pole style, mast-arm length, and pole loadings. The SUDAS Specifications provide figures for both pedestal poles and for mast-arm poles (Figure 13E-1.04). SUDAS standard mast arm pole footing designs (Table 13E-1.01 and Figure 13E-1.04) are based on the following guidelines, parameters, and assumptions:

- Brohm's method for lateral resistance (moment/shear design) per AASHTO *Standard Specifications for Structural Supports for Highway Signs, Luminaires, and Traffic Signals*, 2009, with a safety factor of 2.0.
- FHWA *Drilled Shafts: Construction Procedures and LRFD Design Methods*, May 2010, alpha method for torsion design with a safety factor of 1.0.
- Disturbed soil due to frost: 2.5 feet for moment/shear design, 5.0 feet for torsion design.
- Groundwater assumed present for moment/shear and torsion designs.
- Pole loadings as shown in Figure 13E-1.03, with poles designed per AASHTO 1994 specifications. Wind load equals 80 miles per hour with a gust factor of 1.3.
- Cohesive soils along the length of the footing with an average blow count (N_{60}) greater than or equal to eight, which equates to an average unconfined compressive strength (Q_u) greater than or equal to 2.0 kips per square foot.

For pole loading conditions greater than shown in Figure 13E-1.03, granular soils, or lower strength soils, special footing designs will be required. Soil boring testing should be performed prior to construction to verify soil types and strengths if non-typical soils are suspected.

Table 13E-1.01: Standard Mast Arm Pole Footing Designs*

Loading Type (Figure 13E-1.03)	Maximum Mast Arm Length (feet)	Footing Type (Figure 13E-1.04)
1	35	A
2	45	B
3	55	C
3	60	D
4	70	E
4	80	F

*Maximum loading as per Figure 13E-1.03; for cohesive (non-granular) soils with $Q_u \geq 2.0$ ksf

The footing type for each pole should be included in the contract documents so the contractor will know what is required at the time of bidding.

Figure 13E-1.03: Mast Arm Pole Loadings for Standard Footing Designs

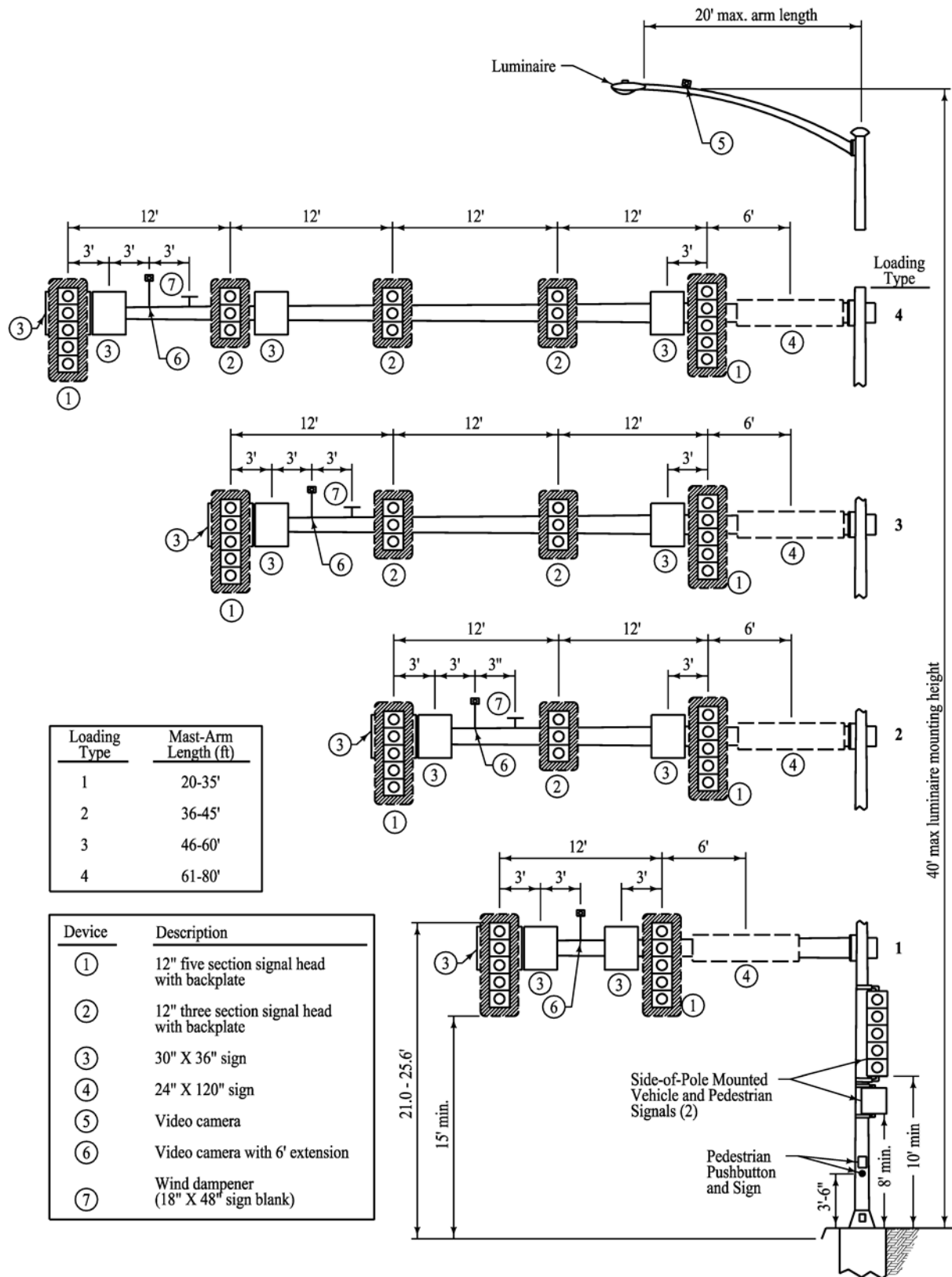
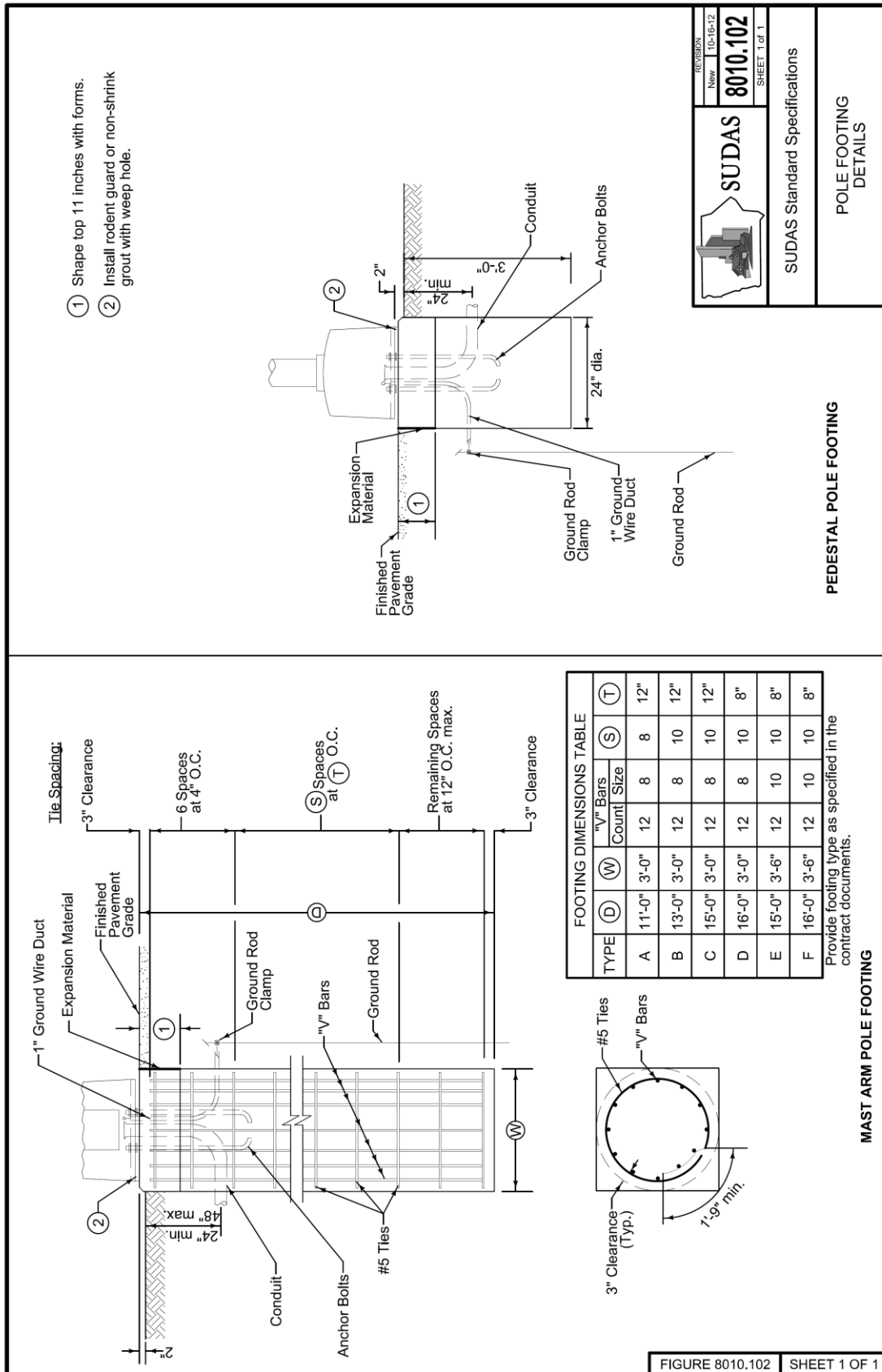

Figure 13E-1.04: Pole Footing Details
(SUDAS Specifications Figure 8010.102)



The designer should ensure that all foundations:

- Are located in compliance with applicable clear zone requirements
- Do not conflict with pedestrian walkways or ramps
- Are at the proper finish grade elevation

An online resource can be found through [Chapter 13 Concrete Foundations](#) (Mn/DOT's 2009 Signal & Lighting Certification Manual), which provides the designer with a photographic resource for foundation types and installation details.

- e. **Bonding and Grounding:** All traffic signal installations must be bonded and grounded according to the National Electrical Code.

Bonding is defined in the Code Book as the permanent joining of metallic parts required to be electrically connected. In a traffic signal, the term is used to describe the electrical and mechanical connection of conduit, metal poles, cabinets, and service equipment.

Grounding is defined in the Code as a conducting connection, whether intentional or accidental, between an electrical circuit or equipment and the earth, or to some conductive body that serves in place of earth.

The designer should ensure that the contract documents include sufficient notation for the traffic signalized intersection to be properly bonded and grounded. This includes placing ground rods at each traffic signal pole and at the controller footing as well as through use of bonding and grounding jumpers within the handholes.

An online resource can be found through [Chapter 12 Bonding and Grounding](#) (Mn/DOT's 2009 Signal & Lighting Certification Manual), which provides the designer with a photographic resource for bonding and grounding details.

2. **Detection:** Detectors provide vehicle and pedestrian inputs to the traffic signal controller. Proper detector installation, operation, and maintenance is critical to the safe and efficient operation of any signalized intersection. An online resource to learn more about detection styles, modes, and typical layouts can be found within Chapter 4 Detection ([Traffic Engineering Manual](#)). Since this document is a PDF, some of the information from this source is provided below.

Detector sizes and locations vary by agency and by location. SUDAS provides a standard drawing for a typical rectangular detector loop (Figure 13E-1.05).

An online resource can be found through [Chapter 15 Detection](#) (Mn/DOT's 2009 Signal & Lighting Certification Manual), which provides the designer with a photographic resource for installation and mounting details.

- a. **Inductive Loop Vehicle Detector:** The most common type of vehicle detection device in use today is the inductive loop. This is a loop of wire imbedded in the pavement (saw cut in existing concrete or NMC loop in new concrete) carrying a small electrical current. When a large mass of ferrous metal passes over the loop, the magnetic field is disturbed and generates, or induces, a change in resonant frequency in the wire. This change in frequency is then recognized by the detector amplifier and signals the controller that a vehicle is present.

Figure 13E-1.05: Inductive Loop Vehicle Detectors
(SUDAS Specifications Figure 8010.104)

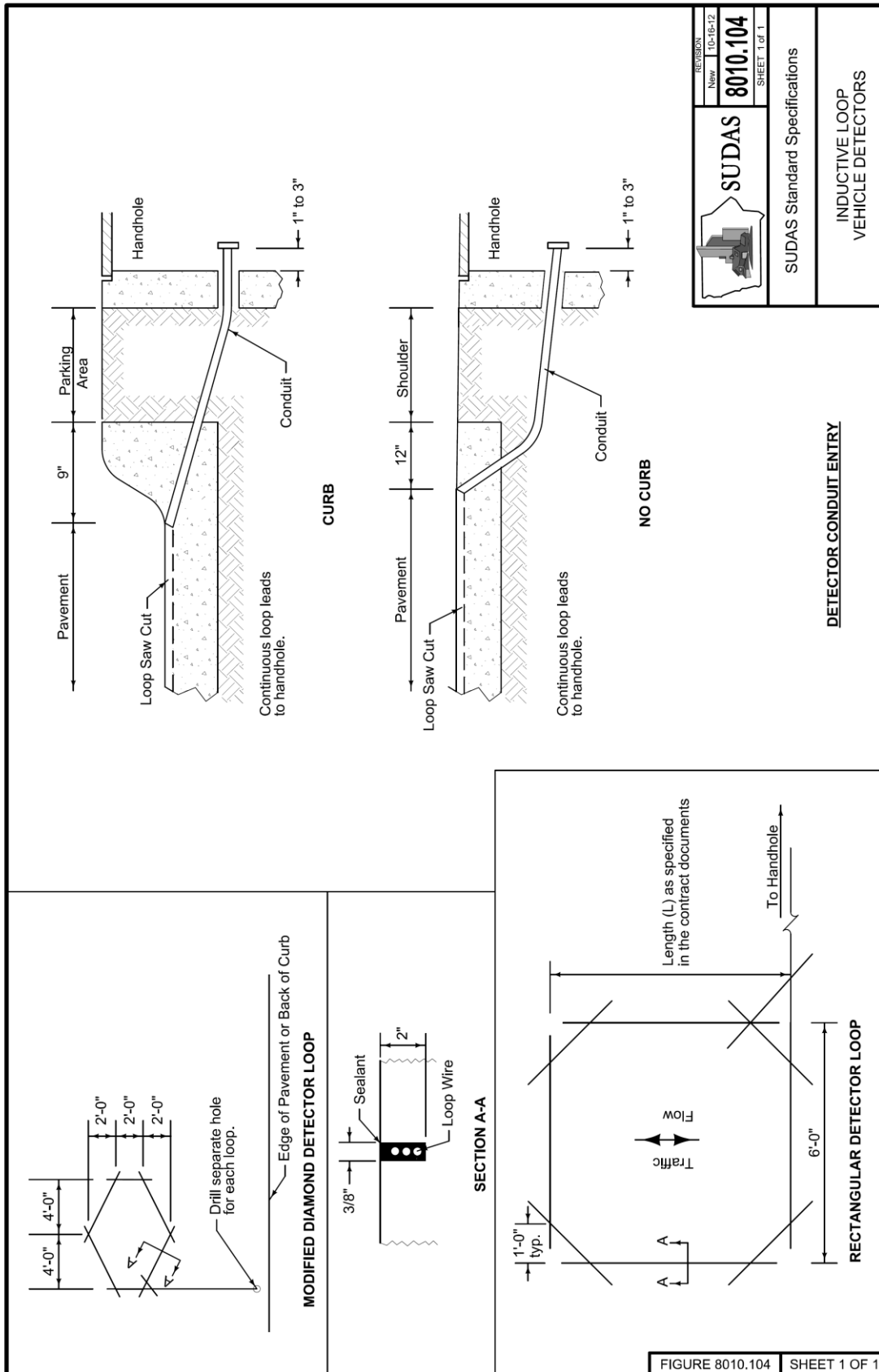

- b. Pedestrian Push Button Detector:** There are a number of ways to provide pedestrian actuation at a signalized intersection. The most common equipment used by far is the pedestrian pushbutton detector. Pressing the button provides a contact closure that actuates the call. There are plenty of examples of good and bad pedestrian pushbutton placement; however, part of the problem is getting the pedestrian to use the button. Specific information regarding pedestrian detectors can be found in the MUTCD Section [4E.08 Pedestrian Detection](#).

An online resource can be found through [Chapter 19](#) Pedestrian Pushbuttons (Mn/DOT's 2009 Signal & Lighting Certification Manual), which provides the designer with a photographic resource for style, installation, and mounting details.

- c. Video Detection Camera System:** Vehicle detection by video cameras is a popular form of vehicle detection within Iowa. The rapid processing of video images provides the detection outputs to the controller. The designer should carefully consider the type of equipment necessary to provide video detection, the maintenance needs of this equipment, and the specific installation and mounting requirements necessary.

Designers should consider relevant manufacturer recommendations and other online resources such as the [Guidelines for Using Video Detection at Intersections and Interchanges](#) by Bonneson at Texas Transportation Institute.

- d. Microwave Vehicle Detector:** Microwave detection is often used within Iowa during temporary signal control to provide simple, non-intrusive vehicle detection. A variety of styles and levels of sophistication exist in the market today.
- 3. Communications:** The designer may be required to provide supplemental specifications for these items given the highly proprietary nature of this equipment and the needs of the contracting agency. Generic specifications have been provided in the SUDAS Specifications.
- 4. Cabinet and Controller:** The designer may be required to provide supplemental specifications for the controller, cabinet, and emergency vehicle pre-emption system given the highly proprietary nature of this equipment. Generic specifications have been provided in the SUDAS Specifications. New information was added to the specifications regarding uninterruptable power supply battery back-up system. The designer should carefully consider the cabinet and mounting requirements of the battery back-up system.

An online resource can be found through [Chapter 22](#) Traffic Signal Cabinets (Mn/DOT's 2009 Signal & Lighting Certification Manual), which provides the designer with a photographic resource for style, installation, and mounting details.

5. Poles, Heads, and Signs:

- a. Vehicle Traffic Signal Head Assembly:** Vehicle signal heads must comply with the following MUTCD sections:

[Section 4D.16](#) Number and Arrangement of Signal Sections in Vehicular Traffic Control Signal Faces

[Section 4D.17](#) Visibility, Shielding, and Positioning of Signal Faces

[Section 4D.18](#) Design, Illumination, and Color of Signal Sections

An online resource can be found through [Chapter 17](#) Traffic Signal Heads (Mn/DOT's 2009 Signal & Lighting Certification Manual), which provides the designer with a photographic resource for style, installation, and mounting details.

- b. Pedestrian Signal Head Assembly:** Pedestrian vehicle signal heads must comply with the following MUTCD sections:

[Section 4E.01](#) Pedestrian Signal Heads

[Section 4E.02](#) Meaning of Pedestrian Signal Head Indications

[Section 4E.03](#) Application of Pedestrian Signal Heads

[Section 4E.04](#) Size, Design, and Illumination of Pedestrian Signal Head Indications

[Section 4E.05](#) Location and Height of Pedestrian Signal Heads

[Section 4E.06](#) Accessible Pedestrian Signals

[Section 4E.07](#) Countdown Pedestrian Signals

- c. Traffic Signal Poles and Mast Arms:** Signalized intersections require poles and mast arms to achieve proper traffic signal and pedestrian head placement. Mast arm details and typical loadings are shown on Figure 13E-1.03; additional mast arm details are shown on Figure 13E-1.06. The designer should ensure that the plan locations comply with all clear zone, sight restriction, and pedestrian flow criteria. Vertical clearance to overhead utility lines is a constant issue that designers should take note of during pre-design field activities. Although the minimum height from the pavement to the bottom of the signal housing is 15 feet, the designer should consider the street classification and the volume of large trucks in establishing the signal height above the pavement. However, the top of the signal housing cannot exceed 25.6 feet above the pavement. If the project being designed has specific requirements relative to the elevation of the end of the mast arm in relation to the connecting point on the vertical pole, include those requirements in the special provisions of the contract documents.

An online resource can be found through [Chapter 16](#) Mast Arm Poles and Pedestals (Mn/DOT's 2009 Signal & Lighting Certification Manual), which provides the designer with a photographic resource for style, installation, and mounting details.

- d. Traffic Signal Pedestal Poles:** Pedestal poles provide alternate mounting heights for signal and pedestrian heads and are much easier to locate within a tight right-of-way. Pedestal pole details and typical head mounting information are shown in Figure 13E-1.07.
- e. Traffic Signs:** The designer must ensure that all signs comply with Iowa DOT standards and the MUTCD.

Figure 13E-1.06: Mast Arm Pole Details
(SUDAS Specifications Figure 8010.105)

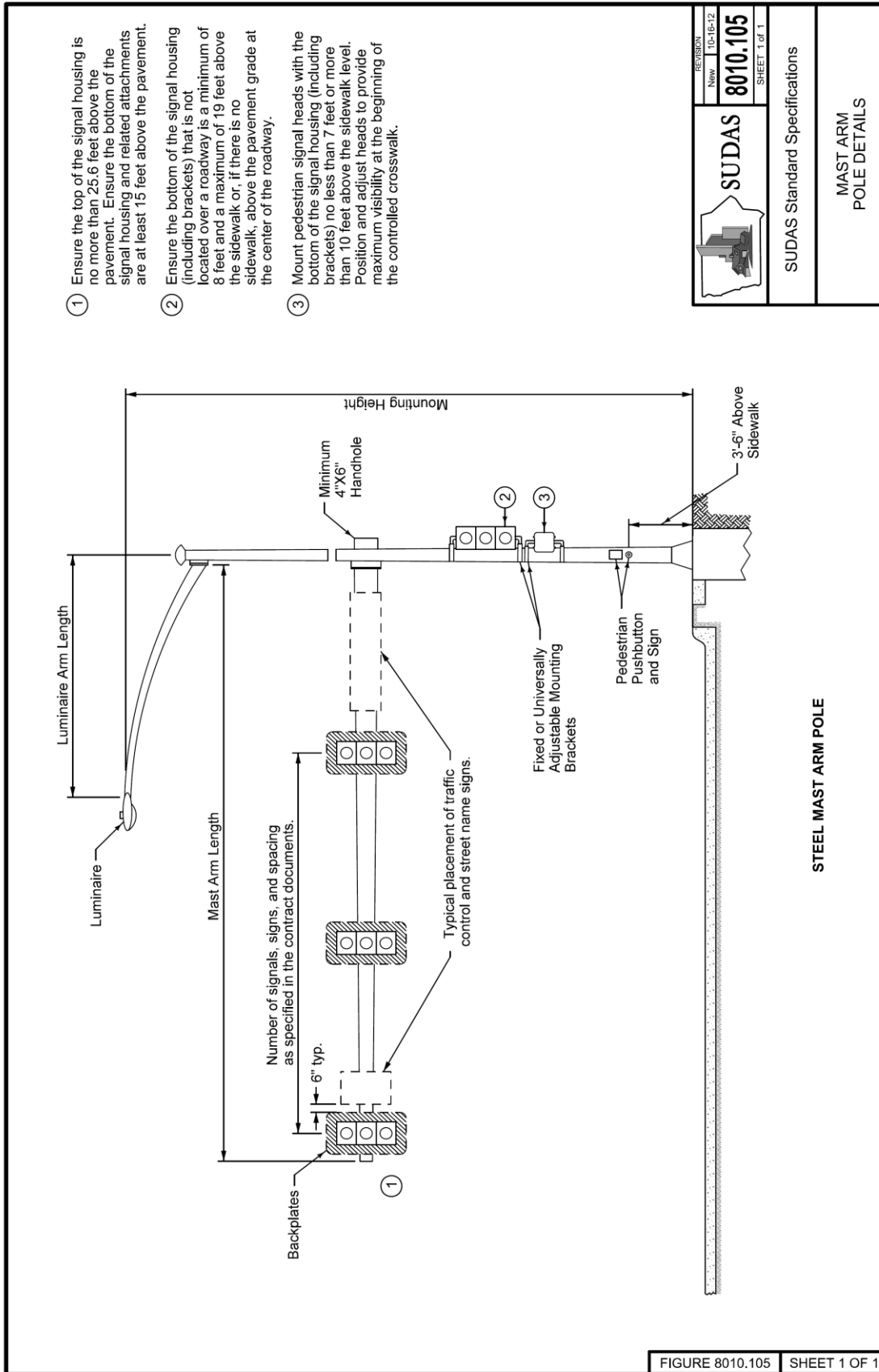

	REVISION	10-16-12
	New	8010.105
SHEET 1 of 1		
SUDAS Standard Specifications		
MAST ARM POLE DETAILS		

FIGURE 8010.105 SHEET 1 OF 1

Figure 13E-1.07: Pedestal Pole and Pedestrian Post Details
(SUDAS Specifications Figure 8010.106)

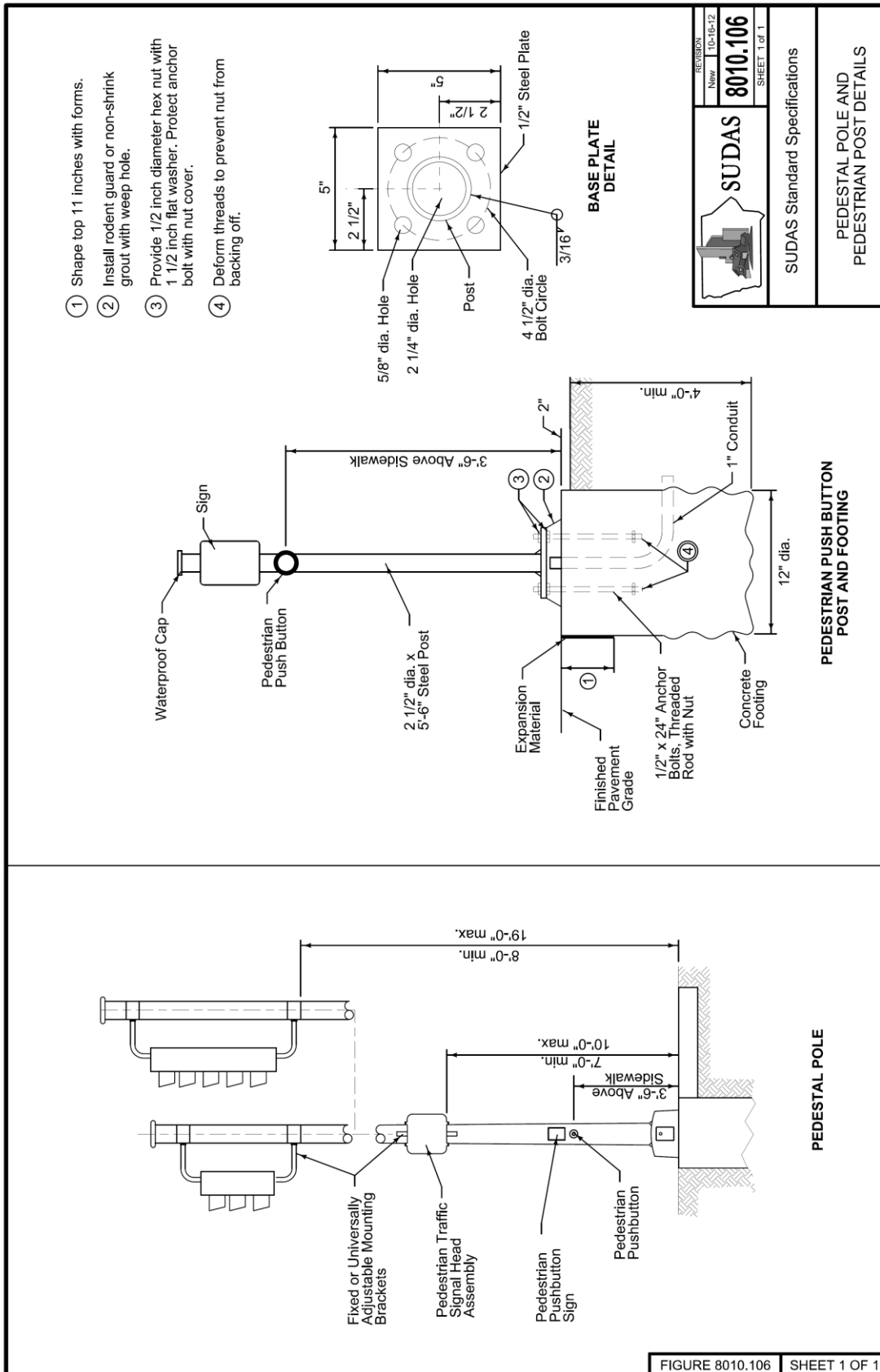

C. Items Requiring Supplemental Specifications

A summary listing of items within SUDAS Specifications Section 8010 requiring supplemental specifications to be provided by the designer includes the following:

- Composite handhole and cover - specify materials and dimensions.
- Foundations - specify foundation dimensions and any conduit stubs needed for future use.
- Communications - specify all traffic monitoring equipment along with any fiber optic equipment and materials.
- Cabinet, controller, and emergency vehicle preemption - specify all relevant equipment.
- Traffic signal poles and mast arms - specify specialty finish for pole if necessary.
- Traffic signs - specify sheeting, sign dimensions, and mounting requirements.

APPENDIX B. SUDAS SPECIFICATIONS SECTION 8010 (TRAFFIC SIGNALS)

TRAFFIC SIGNALS**PART 1 - GENERAL****1.01 SECTION INCLUDES**

- A. Underground
- B. Detection
- C. Communications
- D. Cabinet and Controller
- E. Poles, Heads, and Signs

1.02 DESCRIPTION OF WORK

This part of the specifications includes the furnishing of all material and equipment necessary to complete, in place and operational, traffic control signal(s) as described in the project plans.

1.03 SUBMITTALS

Follow the General Provisions (Requirements) and Covenants as well as the additional requirements listed below. All of the following must be submitted within 30 days after awarding of the contract for the project. Verify the method of submittal with the Jurisdiction.

- A. Schedule of Unit Prices:** Submit a completed schedule of unit prices. Estimates of the work performed on the project will be made by the Jurisdiction and the unit costs will be used to prepare progress payments to the Contractor.
- B. Material and Equipment List:** Submit a completed list of materials and equipment to the Jurisdiction for written approval before any equipment or materials are ordered.
- C. Contractor Certification:** Submit the name(s) and contact information of the International Municipal Signal Association (IMSA) Level II Certified Traffic Signal Technician(s) working on the project and a copy of their IMSA certificate.
- D. Shop Drawings:** Submit shop drawings for traffic signal poles and structures to be furnished on the project. Submit catalog cuts and manufacturer's specifications for all items in the equipment list.

1.04 SUBSTITUTIONS

Comply with Division 1 - General Provisions and Covenants.

1.05 DELIVERY, STORAGE, AND HANDLING

Comply with Division 1 - General Provisions and Covenants.

1.06 SCHEDULING AND CONFLICTS

Comply with Division 1 - General Provisions and Covenants.

1.07 SPECIAL REQUIREMENTS

Comply with the current edition of the MUTCD as adopted by the Iowa DOT.

1.08 MEASUREMENT AND PAYMENT**A. Traffic Signal:**

1. **Measurement:** Lump sum item; no measurement will be made.
2. **Payment:** Payment will be at the lump sum price for traffic signal installation.

B. Temporary Traffic Signal:

1. **Measurement:** Lump sum item; no measurement will be made.
2. **Payment:** Payment will be at the lump sum price for temporary traffic signal installation.

PART 2 - PRODUCTS**2.01 UNDERGROUND****A. Handhole:****1. General:**

- a. **Cable Hooks:** Provide four galvanized steel cable hooks with a minimum diameter of 3/8 inch and a minimum length of 5 inches.
- b. **Granular Base:** Comply with the following gradations; however, the Engineer may authorize a change in gradation, subject to materials available locally at the time of construction.

Sieve	Percent Passing
2"	100
1 1/2"	80 to 90
1"	15 to 20
3/4"	0 to 0.5

- c. **Cover:** Include "TRAFFIC SIGNAL" as a message on the cover. Alternate messages may be required as specified in the contract documents.

2. Precast Concrete Handhole:

- a. **Pipe:** Comply with ASTM C 76. Minimum Class III, Wall B (Iowa DOT Class 2000D). Four, 8 inch knockouts (conduit entrance points) equally spaced around the handhole.
- b. **Casting:** Gray cast iron and certified according to requirements of AASHTO M 306 for a 16,000 pound proof-load (HS-20).

3. Composite Handhole and Cover: Composed of mortar consisting of sand, gravel, and polyester resin reinforced by a woven glass fiber mat or of resin mortar and fiberglass. Ensure the handhole and cover withstands a load of 20,000 pounds. Provide a skid resistant surface on the cover. Provide two 3/8-16 UNC stainless steel hex head bolts with washers.**B. Conduit:****1. General:**

- a. Furnish weatherproof fittings of identical or compatible material to the conduit. Use standard factory elbows, couplings, and other fittings.
- b. Use a manufactured conduit sealing compound that is readily workable material at temperatures as low as 30°F and will not melt or run at temperatures as high as 300°F.

2. Steel Conduit and Fittings:

- a. Comply with ANSI C80.1.
- b. Use weatherproof expansion fittings with galvanized, malleable iron, fixed and expansion heads jointed by rigid steel conduit sleeves. As an option, the fixed head may be integral with the sleeve, forming a one piece body of galvanized malleable iron.
- c. Provide steel bushings.

3. Plastic Conduit and Fittings:

- a. **PVC:**
 - 1) PVC Schedule 40 plastic conduit and fittings complying with NEMA TC-2 (pipe), NEMA TC-3 (fittings), and UL 651 for Schedule 40 heavy wall type.

2.01 UNDERGROUND (Continued)

- 2) Solvent welded, socket type fittings, except where otherwise specified in the contract documents.
 - 3) Threaded adaptors for jointing plastic conduit to rigid metal ducts.
 - 4) Provide bell end fittings or bushings.
- b. HDPE:**
- 1) Comply with ASTM F 2160 (conduit) and ASTM D 3350 (HDPE material), SDR 13.5.
 - 2) Use orange colored conduit.
 - 3) Continuous reel or straight pieces to minimize splicing.
 - 4) For dissimilar conduit connections, provide an adhesive compatible with both materials.
- C. Wiring and Cable:** Provide wire that is plainly marked on the outside of the sheath with the manufacturer's name and identification of the type of the cable.
1. **Power Cable:** Comply with Iowa DOT Article 4185.12.
 2. **Signal Cable:** Comply with IMSA Specifications 19-1 (PVC jacket) or 20-1 (polyethylene jacket) for polyethylene insulated, 600 volt, solid, multi-conductor copper wire, #14 American Wire Gauge (AWG).
 3. **Tracer Wire:** Comply with #10 AWG, single conductor, stranded copper, Type thermoplastic high-heat nylon-coated (THHN), with UL approval, and an orange colored jacket.
 4. **Communications Cable:** Comply with IMSA Specifications 39-2 or 40-2 for #19 AWG, solid copper conductor, twisted pairs. Use polyethylene insulated, aluminum shielded, complying with REA Specification PE-39 for paired communication cable with electrical shielding.
 5. **Category 5E (Cat5E) Cable:** Provide outdoor use rated cable.
 6. **Fiber Optic Cable and Accessories:**
 - a. Furnish fiber optic cable of the mode type, size, and number of fibers specified in the contract documents, and all associated accessories.
 - b. Meet the latest applicable standard specifications by ANSI, Electronics Industries Association (EIA), and Telecommunications Industries Association (TIA).
 - c. Multimode Fiber:
 - Core Diameter: $62.5 \mu\text{m} \pm 1.0 \mu\text{m}$
 - Cladding Diameter: $125.0 \mu\text{m} \pm 1.0 \mu\text{m}$
 - Core Concentricity: $\pm 1\%$
 - Max. Attenuation: 3.50 dB/km @ 850 nm
 - d. Single-Mode Fiber:
 - Typical Core Diameter: $8.3 \mu\text{m} \pm 1.0 \mu\text{m}$
 - Cladding Diameter: $125.0 \mu\text{m} \pm 1.0 \mu\text{m}$
 - Core Concentricity: $\pm 1\%$
 - Attenuation Uniformity: No point discontinuity greater than 0.1 dB at either 1310 nm or 1550 nm
 - Max. Attenuation: 0.25 dB/km @ 1550 nm, 0.35 dB/km @ 1310 nm
 - e. Dual layer UV cured acrylate coating applied by the fiber manufacturer, mechanically or chemically strip-able without damage to the fiber.
 - f. Glass reinforced plastic rod central member designed to prevent the buckling of the cable. Cable core interstices filled with water blocking tape to prevent water infiltration. Dielectric fillers may be included in the cable core where needed to lend symmetry to the cable cross-section.

2.01 UNDERGROUND (Continued)

- g. Buffer tubes of dual layer construction with a polycarbonate inner layer and polyester outer layer. Each buffer tube filled with a water-swellable yarn or tape. Buffer tubes stranded around the central member using reverse oscillation or "SZ" stranding process. Gel-free cable and buffer tubes.
- h. Buffer tubes and fibers meeting TIA/EIA-598A, "Color coding of fiber optic cables," with 12 fibers per buffer tube.
- i. Cable tensile strength provided by a high tensile strength aramid yarn and/or fiber glass.
- j. All dielectric cables, without armoring, sheathed with medium density polyethylene (1.4 mm minimum nominal jacket thickness). Jacketing material applied directly over the tensile strength members and flooding compound. Jacket or sheath marked in a contrasting color with the manufacturer's name and the words "Optical Cable," the year of manufacture, and sequential meter or feet marks. Additionally, provide a durable weather proof label on the cable jacket showing the actual attenuation of each fiber expressed in dB/km.
- k. Cable fabricated to withstand a maximum pulling tension of 600 pounds during installation (short term) and 135 pounds upon installation (long term).
- l. Shipping, storing, and operating temperature range of the cable: -40° C to + 70° C. Installation temperature range of cable: -10° C to + 60° C.
- m. Each fiber of all fiber optic cable tested by manufacturer at the 100% level for the following tests:
 - Proof tested at a minimum load of 50 kpsi (350 Mpa)
 - Attenuation
- n. Meet the appropriate standard Fiber Optic Test Procedure for the following measurements:
 - Fluid Penetration
 - Compound Drip
 - Compressive Loading Resistance
 - Cyclic Flexing
 - Cyclic Impact
 - Tensile Loading and Bending
- o. Make cable ends available for testing. Seal cable ends to prevent moisture impregnation.
- p. Fiber Distribution Panel: Provide a fiber distribution panel capable of terminating a minimum of 24 fibers, or as specified in the contract documents.
- q. Fiber Optic Connectors:
 - 1) ST type connectors of ceramic ferrule and physical contact end finish to terminate multi-mode fibers to equipment.
 - 2) SC type connectors of ceramic ferrule and physical contact end finish to terminate single-mode fibers to equipment.
 - 3) ST or mechanical connectors not allowed for cable splices.
 - 4) Maximum attenuation per connector: 0.75 dB.
- r. Fiber Optic Jumpers/Patch Cords: For connections in the cabinet, provide factory-assembled duplex pigtail jumpers with dielectric strength member, durable outer jacket and ST or SC compatible connectors. Provide adequate length for connections and 2 feet minimum slack.
- s. Fiber Optic Breakout Kits: Provide breakout kits for separation and protection of individual fibers, with buffering tube and jacketing materials suitable for termination of the fiber and fiber optic connector.
- t. Splices/ Splice Enclosures: Fusion splice continuous fiber runs or branch circuit connections in splice enclosures as allowed or specified in the contract documents. Provide environmentally protected outside plant splice enclosures with adequate number of trays to splice all fibers. Maximum attenuation per splice: 0.3 dB.

2.01 UNDERGROUND (Continued)**D. Footings:**

1. Use Class C structural concrete complying with Iowa DOT Section 2403.
2. Use uncoated reinforcing steel complying with Iowa DOT Section 4151.

E. Bonding and Grounding:

1. **Ground Rods:** Provide 5/8 inch by 8 foot copper clad, steel ground rod at each pole and controller footing.
2. **Bonding Jumper or Connecting Wire:** Provide #6 AWG bare conductor, copper wire.

2.02 DETECTION

A. Inductive Loop Vehicle Detector: A detector consists of a conductor loop or series of loops installed in the roadway, lead-in (feeder) cable, and a sensor (amplifier) unit with power supply installed in a traffic signal controller cabinet.

1. **Cables:** All cables must be UL approved.
 - a. **Tube Loop Detector Cable:** Comply with IMSA Specifications 51-5.
 - b. **Preformed Loop Detector Cable:** As approved by the Engineer.
 - c. **Loop Detector Lead-in Cable:** Comply with IMSA Specifications 50-2.
2. **Detector Loop Sealant:**
 - a. Use a rapid cure, high viscosity, liquid epoxy sealant formulated for use in sealing inductive wire loops and leads embedded in pavement. Ensure the cured sealer is unaffected by oils, gasoline, grease, acids, and most alkalis.
 - b. Use a sealant complying with Iowa DOT Materials I.M. 491.18.
3. **Sensor (Amplifier) Unit:**
 - a. Use a sensor unit that is solid state, digital, providing detection channel(s) with an inductance range of 0 to 2,000 micro-henries. Output circuits of the sensor unit will be provided by relays. Vehicle presence will result in a continuous call indication.
 - b. Provide a sensor unit with the following qualities:
 - 1) Sensitivity adjustment to allow as a minimum the selection of high, medium, or low sensitivity.
 - 2) Be capable of providing reliable detection of all licensed motor vehicles.
 - 3) Provide an indicator light for visual indication of each vehicle detection.
 - 4) Will not require external equipment for tuning or adjustment.
 - 5) Provide operation in the pulse mode or presence mode. Ensure mode switch is readily accessible.
 - 6) Provide a self tuning system that is activated automatically with each application of power. Provide automatic and continuous fine tuning to correct for environmental drift of loop impedance.
 - 7) Provide for fail-safe operation (continuous call) in the event of detector loop failure.
 - 8) Ensure each detector channel will respond to a frequency shift in an increasing or decreasing value as occurs with temperature shifts in the pavement without requiring a locked call.
 - 9) Use detector units with delay and extension timing. The delay feature is selected and adjusted externally on the sensor unit housing. Digitally derived timing is selectable in 1 second increments from 0 to 30 seconds. Ensure delay timing inhibits detector output until presence has been maintained for the time selected. Restart delay timer at each new detection.

2.02 DETECTION (Continued)

- 10) Use a sensor unit capable of normal operation without interference and false calls between sensor units ("crosstalk") when installed in the physical environment of the controller cabinet and the electrical environment of the associated electronic equipment installed therein, including other detectors.

B. Pedestrian Push Button Detectors:**1. Assembly:**

- a. Ensure the entire assembly is weather tight, secure against electrical shock, withstands continuous hard usage.
- b. Provide a removable contact assembly mounted in a die cast aluminum case.
- c. Ensure contacts are normally open with no current flowing except at the moment of actuation.
- d. Ensure the contacts are entirely insulated from the housing and operating button with terminals for making connections.
- e. Provide housing with one outlet for 1/2 inch pipe.

2. Operating Button:

- a. Nonrusting metal alloy.
- b. Ensure the button does not protrude out from the case.
- c. Supply ADA compliant operating button.

3. Signs: Furnish push button signs complying with MUTCD.**C. Video Detection Camera System:** Detects vehicles by processing video images and providing detection outputs to the traffic signal controller.**1. Video Detection System and Processors:**

- a. Processor to be card rack mounted or located within camera. Compatible with NEMA TS-1, TS-2, and Type 170 controllers and cabinets.
- b. Must be capable of the following:
 - 1) Shadow rejection without special hardware.
 - 2) Non-impaired operation under light intensity changes.
 - 3) Maintained operation during various weather conditions (e.g. rain, fog, snow).
 - 4) Anti-vibration, 5% rejection based on image change.
 - 5) Ability to select direction of flow parameters.
 - 6) Ability to properly detect directionally.
 - 7) Operate in presence mode with less than 4% error.
- c. Provide user-defined detection zone programming via a graphical user interface (GUI) and any necessary equipment for future programming. Store detection zones in non-volatile memory.
- d. Comply with NEMA TS-1 and TS-2 environmental and physical standards with an operating temperature of -34°C to +60°C, and 0% to 95% relative humidity.
- e. Ensure a factory certified representative from the supplier provides on-site VDS programming and testing.

2. Video Cameras:

- a. Provide a charge-coupled device (CCD) image sensor with variable focus color or black and white lens providing a minimum of 4 to at least a 40 degree horizontal field of view.
- b. Equipped with internal thermostatically controlled heater and external sunshield.
- c. Meet NEMA-4 or NEMA-6P environmental standards.
- d. Use camera cable(s) meeting the manufacturer's recommendations. Provide a continuous run, without splices, from the camera to the controller cabinet.

2.02 DETECTION (Continued)

D. Microwave Vehicle Detectors: Detects all vehicles moving within the field of detection at speeds from 2 to 80 mph.

1. Must be capable of the following:
 - a. Minimum detection range from 3 to 200 feet for all vehicles.
 - b. Pattern spread of the detection field no more than 16 degrees.
 - c. Self-tuning and capable of continuous operation over a temperature range of -35°F to 165°F.
 - d. Side-fire mount or overhead mount.
 - e. Detecting directional traffic and the direction user selectable.
2. Microprocessor based using Doppler microwave at an operating frequency of 10.525 GHz.
3. FCC certification and tested to the applicable FCC specifications.
4. Enclosure constructed of aluminum or stainless steel and water resistant.
5. All user operated controls and adjustments must be clearly marked and easily accessible.
6. Relay detection output to the controller with a minimum 5 amp rating and designed to place a constant call to the controller in the event of any failure.
7. Easily accessible indicator showing activation of detection relay.
8. Required wiring as recommended by the manufacturer.
9. Provide mounting hardware for the type of mounting specified in the contract documents and power supply equipment as recommended by the manufacturer.

2.03 COMMUNICATIONS

A. Traffic Monitoring System: Provide as specified in the contract documents including, video camera in dome, dome mounting bracket and hardware, camera controller, cabling from camera to controller cabinet, and all accessories and hardware necessary for a complete and operational system.

1. Pan/tilt/zoom (PTZ) color camera with automatic conversion to monochrome during low light levels, auto focus, auto-iris control, electronic image stabilization, privacy masking and high resolution 1/4 inch CCD imager. Minimum optical zoom: 25X. Minimum digital zoom: 12X.
2. Camera system provided in a NEMA 4X or IP66 certified rugged weather-resistant package.
3. Provide all required lightning protection for electronics control, power, and coax video outputs.
4. Operating temperature range: -40°C to +50°C.
5. Maximum cable length as specified by camera manufacturer.
6. Provide full 360 degree endless pan and 220 degree tilt under PTZ control.

2.03 COMMUNICATIONS (Continued)

7. Dome electronics capable of programming a minimum of 64 preset views and nine preprogrammed pattern sequences of preset views. All views selectable by the central office computer or a remote control device.
8. Provide encoder and decoder devices as needed to transmit video over existing or proposed communication systems at 30 frames per second.
9. Provide all necessary rack support devices for video viewing and PTZ control.
10. Provide ability to control PTZ and view video remotely.

B. Fiber Optic Hub Cabinet: As specified in the contract documents.

C. Wireless Interconnect Network: Provides two-way data communication between the on-street master controller and local traffic signal controllers.

1. Data Transceiver:

- a. Utilize a license-free spread spectrum radio frequency (902-928 MHz) with frequency hopping technology.
- b. Completely programmable by software. Furnish software to the Jurisdiction.
- c. Built-in diagnostics capabilities.
- d. Configurable as master, slave, or repeater with store and forward capability.
- e. Maintains user selectable power output levels between 0.1 and 1 watt.
- f. Operates with input voltages between 6 VDC and 30 VDC.
- g. RS-232 interface with 115.2 kbps capability.
- h. Operating temperature of -40°C to +75°C.
- i. Receiver sensitivity of -108 to -110 dBm at 10^{-6} BER.
- j. Protected from power surges.
- k. Rack or shelf mounted in controller cabinet and connections for antenna, power, and controller.

2. Antenna:

- a. Capable of transmitting and receiving data between intersections.
- b. Mount near the top of the signal pole nearest the controller cabinet or as specified in the contract documents. Provide engineer-approved mounting hardware.
- c. Connect to transceiver via appropriate cable from pole to signal cabinet in same conduit as traffic signal cable. Conceal cable within a watertight connection at antenna.

2.04 CABINET AND CONTROLLER

A. NEMA Controller, Cabinet, and Auxiliary Equipment: Comply with the latest edition of NEMA TS1 or TS2 standards.

1. Controller:

- a. Solid state modular design with digital timing and capable of accommodating at least eight phases.
- b. Fully prompted, front panel keyboard with menu driven programmability.
- c. Local time base scheduler including automatic accommodation for daylight savings time.
- d. Local coordination control.
- e. Local preemption control with at least four programmable internal preemption sequences.
- f. Current software and documentation.
- g. Data retained in a memory medium that does not require battery backup.

2.04 CABINET AND CONTROLLER (Continued)**2. Cabinet:**

- a. Unpainted aluminum cabinet according to NEMA standards.
- b. Aluminum cabinet riser with same dimensions as cabinet and 12 to 18 inch height, as specified in the contract documents.
- c. Police door with auto/flash switch and on/off power switch for signal heads only. Controller to remain in full operation regardless of switch positions.
- d. Maintenance panel on inside of the main door containing the following test switches.
 - 1) Controller power switch.
 - 2) Detector test switches.
 - 3) Stop time switch.
 - 4) Signal flash switch.
- e. Heavy-duty clear plastic envelope attached to inside wall of cabinet or cabinet door, for cabinet wiring diagrams, 12 inches by 18 inches minimum.
- f. GFI electrical outlet and lamp in accessible location near the front of the cabinet. GFI outlet fused separately from main AC circuit breaker. Fluorescent or LED cabinet lamp connected and fused with GFI outlet.
- g. Back panel positions to accommodate phasing and expansibility specified in the contract documents.
- h. Power protection devices including AC power circuit breakers, radio interference suppressors, and lightning and surge protectors.
 - 1) AC field service single pole, nonadjustable, magnetic breaker rated for 117 VAC operation, NEC approved.
 - 2) Radio interference suppressors (RIS) as required to minimize interference in all broadcast transmission and aircraft frequency bands.
 - 3) Lightning arrestor/surge protector capable of withstanding repeated (minimum of 25) 30,000 ampere surges.
- i. Neatly train wiring throughout the cabinet and riser. Bundle and attach wiring to interior panels using nonconductive clamps or tie-wraps.

- 3. Auxiliary Equipment:** Conflict monitor/malfunction management unit, flasher, load switches, terminals and facilities, and miscellaneous equipment and materials according to NEMA standards.

- B. Uninterruptible Power Supply Battery Backup System:** Monitors 120VAC input from the electric utility source and automatically switches to/from a system consisting of batteries and electronics.

1. Include a maintenance bypass switch to allow operation of the traffic signal system while repairs are made to the battery backup system.
2. Designed to provide a minimum of 4 hours of normal operation.
3. Use cabinet equipment that is plug connected and shelf mounted.
4. Designed to cover a temperature range from -30°F to +165°F and include a surge suppressor.

- C. Emergency Vehicle Preemption System:** As specified in the contract documents.

2.05 POLES, HEADS, AND SIGNS**A. Vehicle Traffic Signal Head Assembly:** Comply with current MUTCD and ITE standards.**1. Housing:**

- a. Individual signal sections made of a durable polycarbonate. Use color specified in the contract documents. Color to be an integral part of the materials composition.
- b. Self-contained unit capable of separate mounting or inclusion in a signal face containing two or more signal sections rigidly and securely fastened together.
- c. Equipped with openings and positive locking devices in the top and bottom so that it may be rotated between waterproof supporting brackets capable of being directed and secured at any angle in the horizontal plane.
- d. Doors and lenses with suitable watertight gaskets and doors that are suitably hinged and held securely to the body of the housing by simple locking devices of non-corrosive material. Doors are to be easily removed and reinstalled without use of special tools.

2. Optical System: Designed to prevent any objectionable reflection of sun rays even at times of the day when the sun may shine directly into the lens.**3. Lenses:** 12 inch diameter polycarbonate. Do not use glass lenses.**4. Visors:****a. Standard Installation:**

- 1) Each signal lens is to have a visor with the bottom 25% open.
- 2) Minimum 0.1 inch in thickness and black in color.
- 3) Fits tightly against the housing door with no filtration of light between the visor and door.
- 4) Minimum length of 9 1/2 inches. Ensure the visor angle is slightly downward.

b. Optically Programmed Sections: Make sure the optical unit and visor are designed as a whole to eliminate the return of outside rays entering the unit from above the horizontal.**5. Terminal Block:**

- a. Three-section signal equipped with a six position terminal block.
- b. Four- and five-section signal equipped with an eight position terminal block.

6. Backplate:

- a. Manufactured one-piece, durable, black plastic capable of withstanding a 100 mph wind.
- b. Provides 5 inches of black field around the assembly.

7. Mounting Hardware:

- a. **Fixed:** 1 1/2 inch aluminum pipe and fittings, natural aluminum finish for galvanized poles or match the pole color. Secure to pole with a minimum 5/8 inch wide stainless steel banding material.
- b. **Universally Adjustable:** Rigid mounted, consisting of both top and bottom brackets and easily adjustable in both horizontal and vertical planes.

8. LED Modules: Comply with current ITE standards.

2.05 POLES, HEADS, AND SIGNS (Continued)**B. Pedestrian Traffic Signal Head Assembly:** Comply with current MUTCD and ITE standards.**1. Housing:**

- a. Made of a durable polycarbonate. Use color specified in the contract documents. Color to be an integral part of the materials composition.
- b. Self-contained unit capable of separate mounting or inclusion in a signal face containing one or more signal sections rigidly and securely fastened together.
- c. Equipped with openings and positive locking devices in the top and bottom so that it may be rotated between waterproof supporting brackets capable of being directed and secured at any angle in the horizontal plane.
- d. Doors and lenses with suitable watertight gaskets and doors that are suitably hinged and held securely to the body of the housing by simple locking devices of non-corrosive material. Doors are to be easily removed and reinstalled without use of special tools.

2. Visor:

- a. Tunnel type visor attached to the housing door by stainless steel screws.
- b. Fit tightly against the housing door to prevent any filtration of light between the door and the visor.
- c. Ensure the visor angle is slightly downward.

3. LED Module:

- a. Provide a LED unit(s) for the filled upraised hand symbol, walking person symbol, and countdown timer.
- b. Ensure immediate blank out of the countdown timer display upon recognizing a shortened "Walk" or a shortened "Flashing Don't Walk" interval.

C. Traffic Signal Poles and Mast Arms:**1. General:**

- a. Mast arm length and vertical pole height as specified in the contract documents.
- b. Ensure the mast arms, poles, and supporting bases are galvanized inside and out according to ASTM A 123.
- c. Continuous tapered, round, steel poles of the transformer base type. Fabricated from low carbon (maximum carbon 0.30%) steel of U.S. standard gauge.
- d. When a transformer base is not specified, provide a 6 inch by 16 inch handhole in the pole shaft for cable access. Provide a cover for the handhole. Secure the cover to the base with simple tools. Hardware to be corrosion resistant.
- e. Ensure minimum yield strength of 48,000 psi after manufacture. Supply base and flange plates of structural steel complying with AASHTO M 183 (ASTM A 36) and cast steel complying with ASTM A 27, Grade 65-35 or better.
- f. Where a combination street lighting/signal pole is specified in the contract documents, the luminaire arm is to be mounted in the same vertical plane as the signal arm unless otherwise specified. Use a single member tapered type arm for the luminaire arm type. Equip the pole with a minimum 4 inch by 6 inch handhole and cover located opposite the signal mast arm.
- g. If allowed by the Engineer, poles and mast arms may be fabricated by welding two sections together, resulting in a smooth joint and factory welded as follows:
 - 1) Ensure a minimum of 60% penetration for plates 3/8 inch and less in thickness for longitudinal butt welds, except within one foot of a transverse butt-welded joint. Ensure a minimum of 80% penetration for plates over 3/8 inch in thickness.
 - 2) Ensure 100% penetration for longitudinal butt welds on poles and arms within one foot of a transverse butt-welded joint.
 - 3) Ensure 100% penetration, achieved by back-up ring or bar, for transverse butt welds for connecting.

2.05 POLES, HEADS, AND SIGNS (Continued)

- 4) Examine 100% of transverse butt welds and 100% penetration longitudinal butt welds by ultrasonic inspection according to the requirements of AWS D1.1-80.AH.
- 5) Comply with Structural Welding Code AWS D1-180, as modified by AASHTO 1981 Standard Specifications for Welding of Structural Steel Highway Bridges and by Supplemental Specifications No. 969.
- h. Provide non-shrink grout (complying with Iowa DOT Materials I.M. 491.13) or a rodent guard (complying with Iowa DOT Materials I.M. 443.01) for placement between the pole base and the foundation.

2. Pole Design:

- a. Comply with AASHTO *Standard Specifications for Structural Supports for Highway Signs, Luminaires, and Traffic Signals*, 1994.
- b. Designed to support the loading necessary for all traffic control equipment. Capable of withstanding winds up to 80 MPH with a 1.3 gust factor without failure.

3. Hardware:

- a. Equipped with all necessary hardware and anchor bolts to provide for a complete installation without additional parts.
- b. Anchor bolts complying with ASTM F 1554 Grade 105, hot dip galvanized and threaded a minimum of 6 inches at one end and have a 4 inch long, 90 degree bend at the other end.
- c. Washers complying with ASTM F 436.
- d. Heavy hex nuts complying with ASTM A 563.
- e. All hardware made of steel, hot dipped galvanized complying with ASTM F 2329, or ASTM B 695, Class 50, Type I, or electrodeposited coated of the same coating thickness and designed for this purpose.

D. Traffic Signal Pedestal Poles:**1. Materials:**

- a. **Pedestal:** The height from the bottom of the base to the top of the shaft as specified in the contract documents.
- b. **Pedestal Shaft:** Schedule 80 with satin brush or spun finish aluminum tubing. Top of the shaft outer diameter to be 4 1/2 inches and provided with a pole cap. Supply base collar for poles with shaft lengths greater than 10 feet.
- c. **Pedestal Base:** Cast aluminum, square in shape, with a handhole.
 - 1) **Handhole:** Minimum of 6 inches by 6 inches and equipped with a cast aluminum cover that can be securely fastened to the base with the use of simple tools.
 - 2) **Base:** Minimum weight of 20 pounds with a four bolt pattern uniformly spaced on a 12 1/2 inch diameter bolt circle. Meet or exceed AASHTO breakaway requirements.

2. **Anchor Bolts:** Four 3/4 inch by 15 inch steel, hot dip galvanized anchor bolts with right angle bend at the bottom end, complete with all hardware required for installation.

2.05 POLES, HEADS, AND SIGNS (Continued)**E. Pedestrian Push Button Post:****1. Material:**

- a. Post:** Standard weight (Schedule 40) pipe complying with ASTM F 1083, galvanized inside and out; 2 1/2 inches in diameter.
- b. Cap:** Waterproof cap complying with ASTM F 626.
- c. Anchor Bolts:** Four 1/2 inch by 24 inch steel, hot dip galvanized anchor bolts complete with all hardware required for installation.
- d. Non-shrink Grout:** Comply with Iowa DOT Materials I.M. 491.13 or a rodent guard (complying with Iowa DOT Materials I.M. 443.01) for placement between the post base and the foundation.
- e. Base Plate:** Provide a 5 inch square, 1/2 inch thick galvanized steel base plate with a 4 1/2 inch bolt circle.

F. Traffic Signs:

1. Comply with Iowa DOT Section 4186.
2. Use a universally adjustable mast arm mounted sign bracket.
3. Comply with MUTCD and the contract documents for the street name sign dimensions, letter height and font, and sheeting.

PART 3 - EXECUTION**3.01 UNDERGROUND****A. Handhole:****1. Locations:**

- a. Do not construct in ditch bottoms, low areas where ponding of water may occur, or where they will be subject to normal vehicular traffic.
- b. With Engineer approval, additional handholes may be placed, at no additional cost to the Contracting Authority, to facilitate the work.

2. Excavation: Excavate as necessary to accommodate the handhole and granular base.**3. Granular Base:** Install 8 inch thick granular base extending a minimum of 6 inches beyond the outside walls of the handhole.**4. Placement:**

- a. In paved areas, install the handhole at an elevation so the casting is level and flush with the pavement. In unpaved areas, install the handhole approximately 1 inch above the final grade.
- b. Verify ring placement. Invert rings when installed in paved areas.

5. Conduit:

- a. Remove knockouts as necessary to facilitate conduit entrance.
- b. Extend conduit into the handhole, through a knockout, approximately 2 inches beyond the inside wall. Conduit to slope down and away from the handhole.
- c. Place non-shrink grout (complying with Iowa DOT Materials I.M. 491.13) in the opening of the knockout area after placement of conduit.

6. Cable Hooks: Install cable hooks centered between the knockouts and the top of the handhole.**7. Backfill:** Place suitable backfill material according to Section 3010.**8. Casting:** Place the casting on the handhole. Ensure the final elevation meets the handhole placement requirements.**B. Conduit:****1. General:**

- a. Place conduit to a minimum depth of 30 inches and a maximum depth of 60 inches below the gutterline. When conduit is placed behind the curb, place to a minimum depth of 24 inches and a maximum depth of 48 inches below top of curb.
- b. Change direction at handholes or by bending, such that the conduit will not be damaged or its internal diameter changed. Ensure bends are uniform in curvature and the inside radius of curvature of any bend is no less than six times the internal diameter of the conduit.
- c. On the exposed ends of conduit, place bell-end fittings on PVC or HDPE conduit and bushings on steel conduit prior to installing cable. Extend all conduits a minimum of 2 inches and a maximum of 4 inches above the finished surface of any footing or structural base.

3.01 UNDERGROUND (Continued)

- d. When it is necessary to cut and thread steel conduit, do not allow exposed threads. Ensure conduits and fittings are free from burrs and rough places. Clean, swab, and ream conduit runs before cables are installed. Use nipples to eliminate cutting and threading where short lengths of conduit are required. Coat damaged galvanized finish on conduit with zinc rich paint. Use only galvanized steel fittings with steel conduit.
- e. Pack conduit ends with a conduit sealing compound.

2. Trenched Installation:

- a. Place backfill in layers not to exceed 12 inches in depth with each layer thoroughly compacted before the next layer is placed. Ensure backfill material is free of cinders, broken concrete, or other hard or abrasive materials.
- b. Remove all surplus material from the public right-of-way as soon as possible.

3. Trenchless Installation:

- a. When placing conduit under pavements, use the trenchless installation methods described in Section 3020.
- b. If trenchless methods that compact soils in the bore path are used, provide sufficient cover to prevent heaving of overlying paved surfaces.
- c. Do not allow pits for boring to be closer than 2 feet to the back of curb, unless otherwise specified in the contract documents.

C. Wiring and Cable:

1. Where practical, follow color codes so that the red insulated conductor connects to the red indication terminal, yellow to yellow, and green to green. Ensure cables are properly labeled at the controller by durable labels, or other appropriate methods, attached to the cables. Label home runs for cables as follows: northwest corner is red, southeast corner is blue, northeast corner is green, and southwest corner is orange.
2. Install continuous runs of vehicle and pedestrian signal cables from the vehicle or pedestrian signal head to the handhole compartment of the signal pole base. Install continuous runs of vehicle and pedestrian signal cables from the handhole compartment of the signal pole base to the terminal compartment in the controller cabinet. Do not splice signal cables in underground handholes.
3. Install continuous runs for video detection and emergency vehicle preemption cables from the unit to the controller cabinet.
4. Install continuous runs of power lead-in cables from the service point to the meter socket and from the meter socket to the controller cabinet.
5. Install continuous detector cable from each detector loop to the first handhole adjacent to the loop. Ensure cables are properly labeled at the controller by durable labels, or other appropriate methods, attached to the cables. Install continuous homerun cable from the splice made in the first handhole to the terminal compartment in the controller cabinet. Attach the drain wire of the shielded cable to the ground in the controller cabinet.
6. Provide a minimum of 4 feet of additional cable at each handhole and loosely coil the extra cable on the handhole cable hooks. Provide a minimum of 2 feet of additional cable at each signal pole (measured from the handhole compartment in the pole to the end of the cable). Provide a minimum of 10 feet of additional cable at each controller base.
7. Pull cables through conduit using a cable grip designed to provide a firm hold upon the exterior covering of the cable or cables, and minimize dragging on the ground or pavement.

3.01 UNDERGROUND (Continued)

8. Install a tracer wire in all conduits with the exception of conduits between detector loops and handholes. Use a silicon-filled wire nut to splice the tracer wire in each handhole and at the controller to form a continuous run.
9. Fiber Optic Cable and Accessories:
 - a. Use a suitable cable feeder guide between the cable reel and the face of the conduit to protect the cable and guide the cable directly into the conduit off the reel. During the installation, carefully inspect cable jacket for defects. If defects are found, notify the Engineer prior to any additional cable being installed. Take care when pulling the cable to ensure the cable does not become kinked, crushed, twisted, snapped, etc.
 - b. Attach a pulling eye to the cable and use to pull the cable through the conduit. Use a pulling swivel to preclude twisting of the cable. Lubricate cable prior to entering the conduit with a lubricant recommended by the manufacturer. Use dynamometer or break away pulling swing to ensure the pulling tension does not exceed the specified force of 600 pounds or the cable manufacturer's recommendations, whichever is less. Do not allow the cable to twist, stretch, become crushed, or forced around sharp turns that exceed the bend radius or scar or damage the jacket. Manually assist the pulling of the cable at each pull point.
 - c. Do not pull cable through any intermediate junction box, handhole, pull box, pole base, or any other opening in the conduit unless specified in the contract documents. Install cable by pulling from handhole or controller cabinet to the immediate next downstream handhole or cabinet. Carefully store the remaining length of cable to be installed in the next conduit run(s) in a manner that is not hazardous to pedestrian or vehicular traffic, yet ensures that no damage to the cable occurs. Storage methods are subject to Engineer approval.
 - d. At each handhole, visibly mark or tag cable, "CITY (or COUNTY) FIBER OPTIC"
 - e. Secure cables inside controller cabinet so that no load is applied to exposed fiber strands.
 - f. Ensure the radius of the bend for static storage is no less than 10 times the outside diameter of the cable, or as recommended by the manufacturer. Ensure the radius of the bend during installation is no less than 15 times the outside diameter of the cable, or as recommended by the manufacturer.
 - g. Provide cable slack in each handhole, junction box, and cabinet as specified in the contract documents. Where handholes or junction boxes lack sufficient area for cable storage or bend radius requirements, provide equivalent additional slack in adjacent facilities. Coil and bind slack cable at three points around the cable perimeter and support in its static storage position.
 - h. Install fiber optic accessories according to the manufacturer's recommendations and as specified in the contract documents.
10. Fiber Optic Cable Field Testing: Provide for each fiber both on-reel testing prior to installation and final testing after installation using a high-resolution optical time domain reflectometer (OTDR). Conduct measurements for single-mode fibers at 1310 ± 30 nanometer wavelength. Conduct measurements for multimode fibers at 850 ± 30 nanometer wavelength. Record the identification, location, length, and attenuation measurements of each fiber, and furnish test reports to the Engineer. Replace any cable that fails testing, at no additional cost to the Contracting Authority.
 - a. On-reel Testing: Perform testing for attenuation and continuity using OTDR and a pigtail splice. Complete testing in one direction only. Acceptable test results will be within $\pm 3\%$ of factory-supplied attenuation measurements. Except for access to and test preparation of one end of the newly furnished cable, preserve the cable in its originally-shipped condition. Furnish test reports to the Engineer prior to installation.

3.01 UNDERGROUND (Continued)

- b. Cable Segment Testing: Perform an end-to-end attenuation test of each terminated fiber of each fiber optic cable. Perform testing using hand-held optical test sets. Include test results in documentation package provided to the Engineer at the conclusion of the project. Acceptable test results will not exceed the cumulative specified losses of the components. For example, at 850 nanometers, a one kilometer multimode fiber link with two splices and a connector on each end will not exceed 5.6 dB:

1.0 km x 3.5 dB/km:	3.5 dB
0.3 dB per splice x 2:	0.6 dB
0.75 dB per connector x 2:	<u>1.5 dB</u>
Maximum allowable loss:	5.6 dB

Repair or replace any cable segment that fails testing. Retest any repaired or replaced cable. Submit complete documentation of test results to the Engineer (hard copy or electronically).

- c. Final System Testing: After complete fiber optic system is installed and terminated, but prior to capping unused fibers, perform OTDR readings on all cables to ensure that each section is in compliance with the specifications. Provide copies of OTDR trace signatures for all fibers for all cable sections to the Engineer. Also provide test results for attenuation test for the installed fibers using the insertion loss procedure and the transmitter/receiver power level test and the continuity test.

D. Footings:

1. **Excavation:** Excavate to the size, shape, and depth specified in the contract documents. Ensure the bottom of all foundations rest securely on firm undisturbed soil. Minimize overexcavation to ensure support and stability of the foundation.
2. **Footing:** Provide a means for holding all of the following elements rigidly in place while the concrete is being placed.
 - a. **Forms:**
 - 1) Set the forms level or sloped to meet the adjacent paved areas.
 - 2) When adjacent to paved areas, shape the top 11 inches of the footing to be square and flush with the surrounding paved area. Provide preformed expansion material between the footing and paved areas.
 - 3) When installed in an unpaved area, set the top of the footing 2 inches above the surface of the ground.
 - b. **Reinforcing Steel:** Install reinforcing steel.
 - c. **Conduit:** Install conduit.
 - d. **Anchor Bolts:**
 - 1) Set anchor bolts using a template constructed to accommodate the specified elevation, orientation, and spacing according to the pole and controller manufacturer's requirements.
 - 2) Center the pole anchor bolts within the concrete footing.
 - 3) Protect the anchor bolts until poles are erected.
 - 4) Orient controller footing with the back of the cabinet toward the intersection such that the signal heads can be viewed while facing the controller, unless otherwise directed by the Engineer.
 - e. **Concrete:**
 - 1) Place concrete to form a monolithic foundation. Consolidate concrete by vibration methods.
 - 2) Finish the top of the base level and round the top edges with an edging tool having a radius of 1/2 inch. Provide a rubbed surface finish on the exposed surface of the footing.

3.01 UNDERGROUND (Continued)

- 3) Allow the footings to cure a minimum of 4 days prior to erecting the poles and 7 days prior to installing the mast arms. Times may be shortened if supported by strength test results.

3. Backfill: Place suitable backfill material according to Section 3010.

E. Bonding and Grounding:

1. Ensure the traffic signal installation is grounded as required by the National Electric Safety Code.
2. Install a ground rod at each signal pole and controller footing.
3. Use PVC conduit within the footing to accommodate the connection between the top of the footing and the ground rod.
4. Bond poles to ground rods with copper wire. Connect ground wires to ground rods with approved mechanical connectors.
5. Bond rigid steel conduit ends in handholes with copper wire and approved fittings.

3.02 DETECTION**A. Detector Loop Cable Installation:**

1. Coordinate the location of the detector loop with the Engineer. Obtain the Engineer's approval prior to cutting the pavement.
2. Saw to ensure proper depth and alignment of the slot. Make a 2 inch deep clean, straight, well-defined 3/8 inch wide saw cut without damage to adjacent areas. Overlap the saw cuts where the detector loop changes direction to provide full depth at all corners. Do not use right angle or corners less than 90 degrees.
3. Before installing the detector loop cable, check the saw cuts for the presence of jagged edges or protrusions and remove if present. Clean and dry the saw cuts to remove cutting dust, grit, oil, moisture, or other contaminants. Clean by flushing with a stream of water under pressure. Use oil-free compressed air to dry the saw cuts.
4. Install detector loop cable without damage. Place three turns of the detector loop cable into the saw cut. Seal the ends of the tubing at the time of placement to prevent entrance of moisture.
5. Ensure the detector loop cables are in the bottom of the saw cut. Place detector loop sealant within the saw cut area. Comply with the manufacturer's instructions for mixing and using the detector loop sealant.
6. Install preformed loop detector according to the manufacturer's recommendations.
7. Identify each detector loop cable in the handhole by phase and location. Wind loops that are physically adjacent in an individual lane or adjacent lanes with opposite rotation (i.e. #1 clockwise, #2 counter-clockwise, #3 clockwise, etc.). Rotation reversal can be accomplished by reversing leads at the handhole.
8. Twist, with at least five turns per foot, all lengths of loop wires and tubing that are not embedded in the pavement.

3.02 DETECTION (Continued)

9. Identify all detector loop lead-in cables with appropriate detector numbers.
10. Use a detector loop cable splice kit for the electrical splice between the detector loop cable and the detector loop lead-in cable to the controller.
 - a. Ensure splice kit provides a watertight protective covering for the spliced wire, the shielding on the detector loop lead-in cable, and the end of the tubing containing the detector loop cable.
 - b. Use a manufactured electrical splice kit approved by the Engineer.
11. Test all loops and document by using the following procedures:
 - a. Determine the insulation resistance of the loop wire using a "megger" with 500V applied to either loop wire to earth ground. The resistance is to be greater than 100 megohms.
 - b. Determine the inductance of the loop using a loop inductance meter.

B. Pedestrian Push Button Detectors:

1. Install according to the manufacturer's recommendations.
2. Seal the wire entrance into the pedestrian push button assembly.

C. Video Detection Camera System: Install according to the manufacturer's recommendations and as specified in the contract documents.**3.03 COMMUNICATIONS****A. Traffic Monitoring System:** Install according to the manufacturer's recommendations and as specified in the contract documents, as well as the following:

1. Position camera dome on the pole as directed by the Engineer.
2. Test installed system under the supervision of the Engineer, and certify as fully-functional.

B. Fiber Optic Hub Cabinet: Install according to the manufacturer's recommendations and as specified in the contract documents.**3.04 CABINET AND CONTROLLER****A. Controller, Cabinet, and Auxiliary Equipment:**

1. Install according to the manufacturer's recommendations and as specified in the contract documents.
2. Install on pre-placed caulking material on the concrete base. After the cabinet is installed in place, place caulking material around the base of the cabinet.

B. Controller: Install according to the manufacturer's recommendations and as specified in the contract documents.**C. UPS Battery Backup System:** Install according to the manufacturer's recommendations and as specified in the contract documents.**D. Emergency Vehicle Preemption System:** Install according to the manufacturer's recommendations and as specified in the contract documents.

3.05 POLES, HEADS, AND SIGNS**A. Vehicle and Pedestrian Traffic Signal Heads:**

1. Inspect each signal head assembly while still on the ground for the following:
 - a. Physical defects
 - b. Visor type
 - c. LED wattage
 - d. Lens orientation
 - e. Wiring connections
2. Attach signal head mounting hardware according to the manufacturer's recommendations. Apply anti-seize compound to all mechanical fasteners.
3. Adjust each signal head both vertically and horizontally to approximate a uniform grade of all like signal heads.
4. During the course of construction and until the signals are placed in operation, cover signal faces or turn away from approaching traffic. When ready for operation, plumb and aim the heads.

B. Traffic Signal and Pedestal Poles and Pedestrian Push Button Posts:

1. Erect all poles and posts vertically under normal load.
2. Securely bolt the bases to the cast-in-place concrete foundations.
 - a. Mast Arm Poles: Provide footing type (A through F) as specified in the contract documents. Level by using two nuts on each anchor bolt or according to the manufacturer's recommendations.
 - b. Pedestal Poles: Level by using metal shims and one nut on each anchor bolt or according to the manufacturer's recommendations.
 - c. Pedestrian Push Button Posts: Weld the post to the base plate using a minimum 3/16 inch weld. Level by using two nuts on each bolt.
3. After leveling the poles, use non-shrink grout or a rodent guard between the pole base and the foundation. When non-shrink grout is used, neatly finish exposed edges of grout to present a pleasing appearance, and place a weep hole in the grout.
4. Apply anti-seize compound to all mechanical fasteners on pole access doors.
5. Install pedestrian push button post caps with tamper-proof set screws per manufacturer's direction or by driving the cap a minimum of 1/2 inch onto the post.

C. Traffic Signs: Install signs using universally adjustable sign brackets banded to the pole. Apply anti-seize compound to all mechanical fasteners.

3.06 TEMPORARY TRAFFIC SIGNAL

Construct according to Figure 8010.107 and to the configuration specified in the contract documents.

3.07 SURFACE RESTORATION

- A. Replace or reconstruct features removed as a part of the work, such as sidewalks, driveways, curbs, roadway pavement, unpaved areas, or any other items.
- B. Complete restoration according the applicable sections of the SUDAS Standard Specifications or as directed by the Engineer.

3.08 TESTING

- A. Notify the Engineer 48 hours in advance of the time and date the signal or signal system will be ready for turn on. Do not turn on the signal or signal system without authorization of the Engineer.
- B. Ensure a representative from the manufacturer and/or supplier of signal controller or other authorized person is at the project site when the signal controllers are ready to be turned on to provide technical assistance including, as a minimum, programming of all necessary input data.
- C. All required signal timing data will be provided by the Engineer.
- D. A test period of 30 calendar days will start upon confirmation from the Engineer that the signal or signal system is operating consistent with the project requirements. Any failure or malfunction of the equipment furnished by the Contractor, occurring during the test period will be corrected by the Contractor at no additional cost to the Contracting Authority. Upon confirmation by the Engineer that any failure or malfunction has been corrected, a new test period of 30 calendar days will start, exclusive of minor malfunctions such as lamp burnouts. Repeat this procedure until the signal equipment has operated satisfactorily for 30 consecutive calendar days.
- E. After signal turn on and prior to completion of the 30 calendar day test period, respond, within 24 hours, to perform maintenance or repair of any failure or malfunction reported.

3.09 DOCUMENTATION

- A. Provide file documentation packages with each signal system, consisting of the following:
 - 1. Complete cabinet wiring diagram.
 - 2. Complete physical description of the equipment.
 - 3. Controller printout or equal documentation of initial controller settings installed in the field or in the office.
 - 4. Product manuals for all cabinet equipment.
 - 5. Standard industry warranties on equipment supplied.
 - 6. Documentation of field cable labeling scheme.
 - 7. Diagram of phasing and detector locations.
 - 8. One set of as-built construction plans indicating changes from the original contract documents.
- B. Supply two complete sets of documentation. One set to be placed in the controller cabinet and the other set (less construction plan) to be delivered to the Engineer.

END OF SECTION

- ① Shape top 11 inches with forms.
- ② Bolt spacing and conduit locations as specified by the manufacturer.

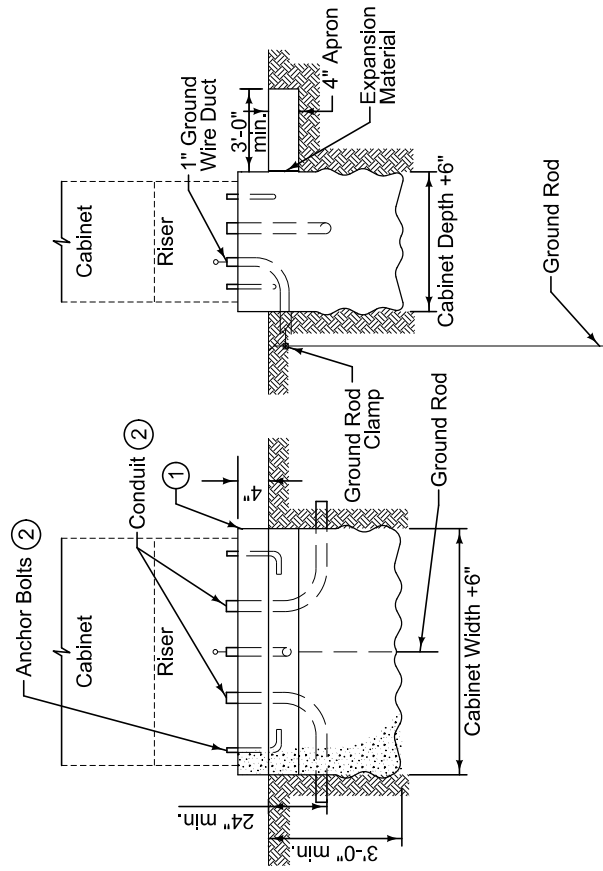

NEMA CONTROLLER CABINET FOOTING

	REVISION	10-16-12
	New	
	8010.101	
SHEET 1 of 1		

SUDAS Standard Specifications

CABINET FOOTING
DETAILS

- ① Shape top 11 inches with forms.
- ② Install rodent guard or non-shrink grout with weep hole.

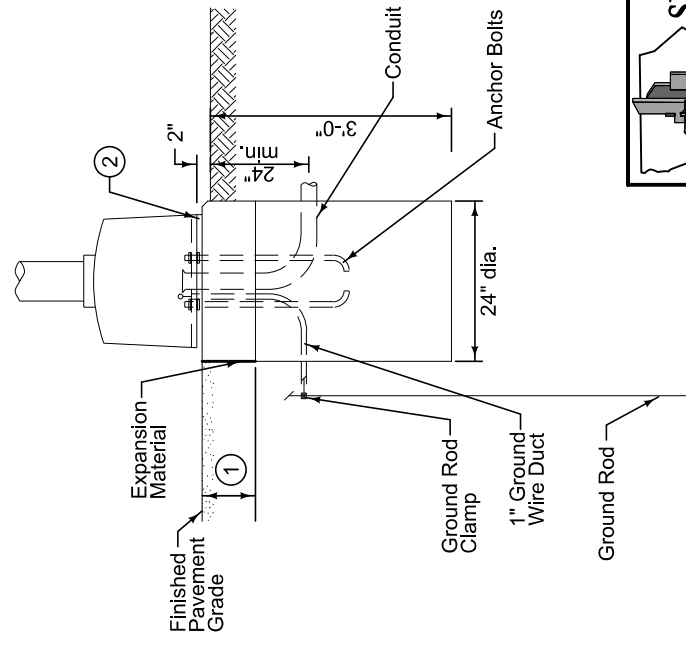

REVISION
New 10-16-12
SUDAS 8010.102
SHEET 1 of 1

SUDAS Standard Specifications
POLE FOOTING DETAILS

PEDESTAL POLE FOOTING

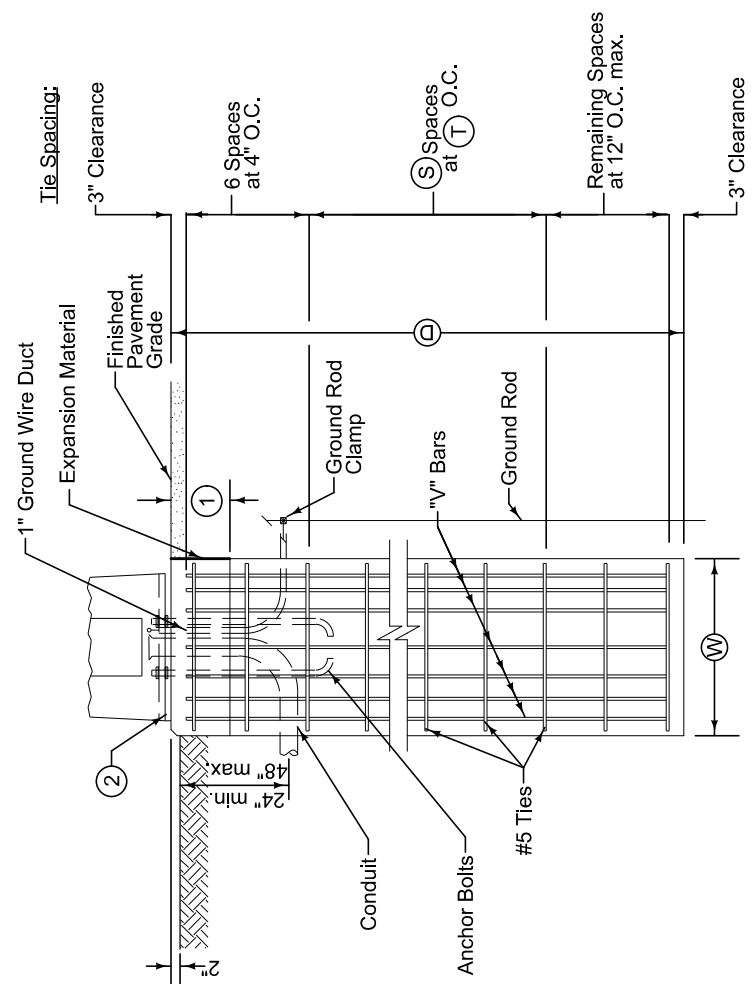

TYPE	(D)	(W)	"V" Bars		(T)
			Count	Size	
A	11'-0"	3'-0"	12	8	8
B	13'-0"	3'-0"	12	8	10
C	15'-0"	3'-0"	12	8	10
D	16'-0"	3'-0"	12	8	10
E	15'-0"	3'-6"	12	10	10
F	16'-0"	3'-6"	12	10	10

Provide footing type as specified in the contract documents.

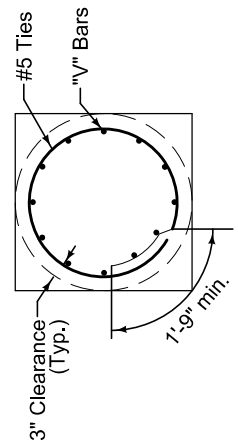

MAST ARM POLE FOOTING

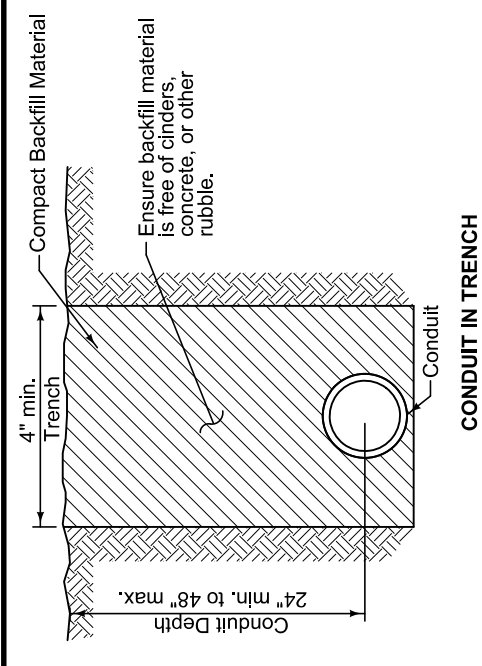

CONDUIT IN TRENCH

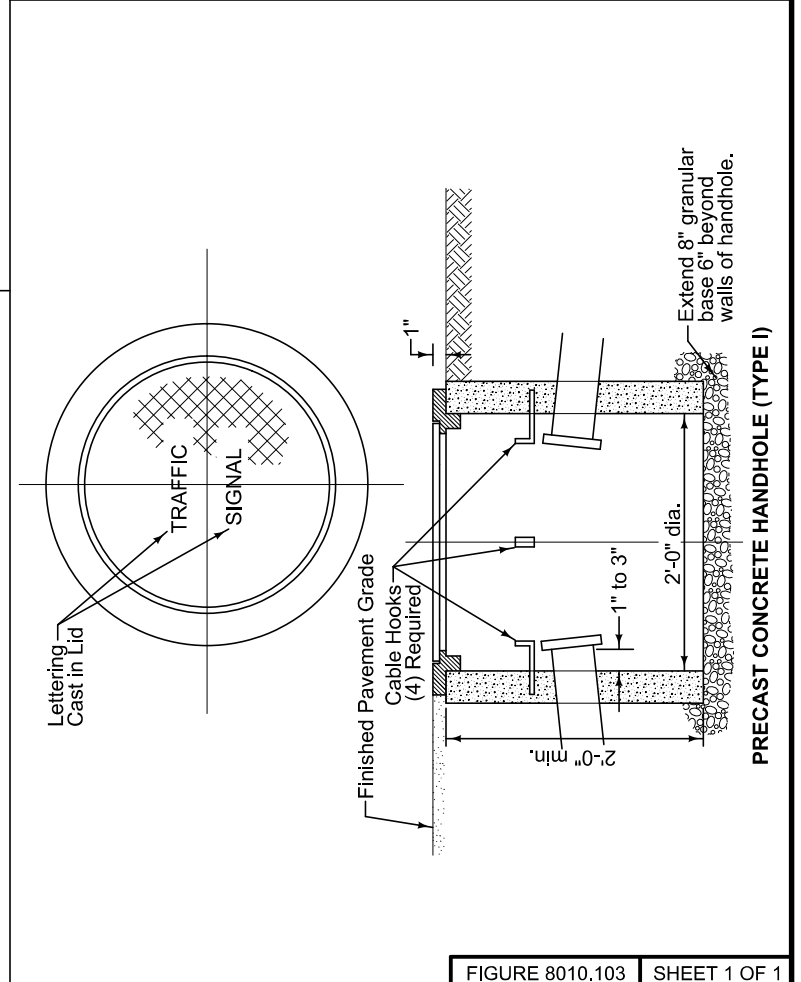

PRECAST CONCRETE HANDHOLE (TYPE I)

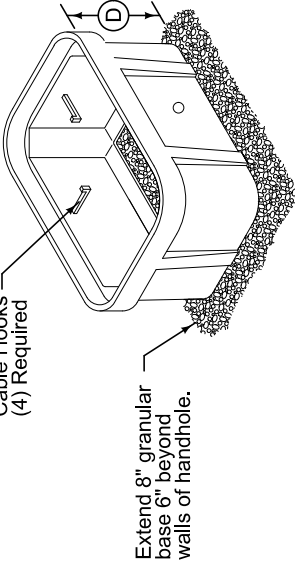
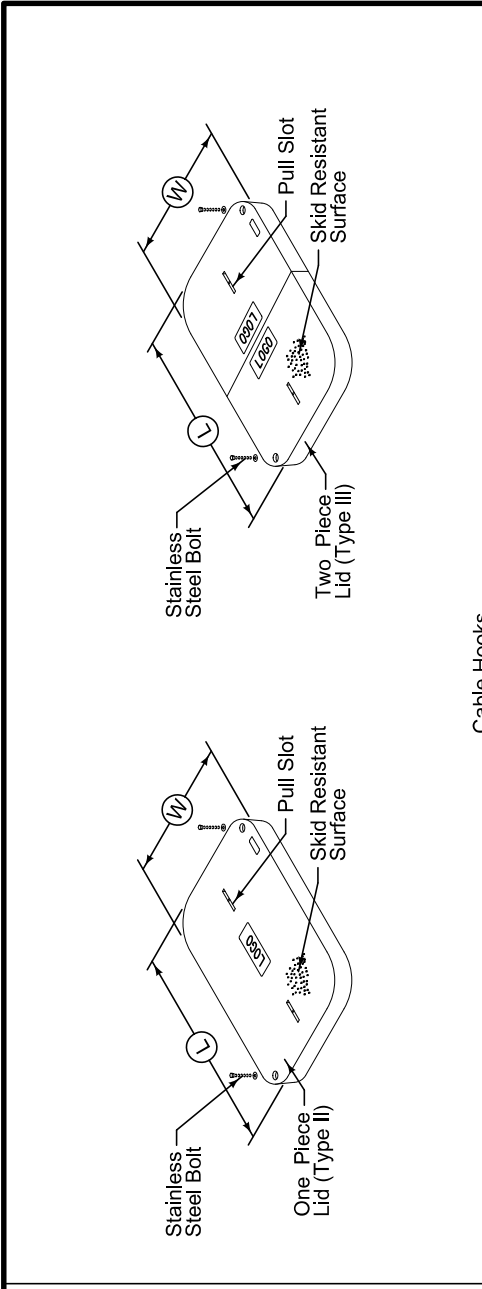

HANDHOLE DIMENSIONS TABLE (NOMINAL)

TYPE	(L)	(W)	(D)
II	36"	24"	30"
III	48"	30"	36"

PRECAST COMPOSITE HANDHOLE

SUDAS

REVISION
New 10-16-12
8010.103
SHEET 1 of 1

SUDAS Standard Specifications

CONDUIT AND HANDHOLES

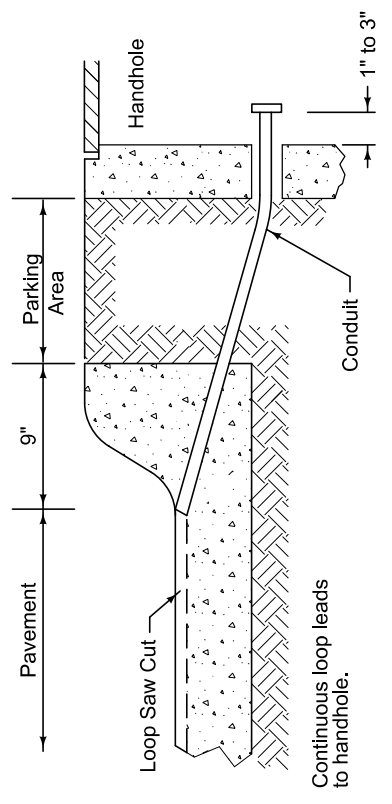
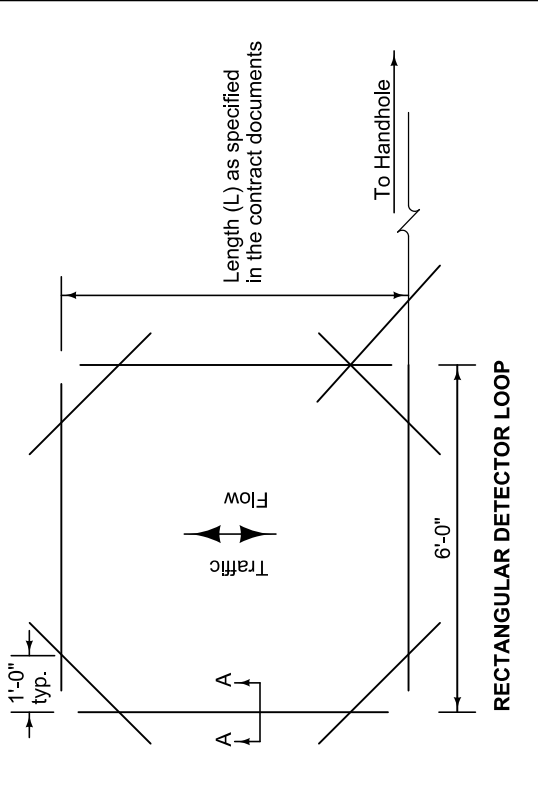
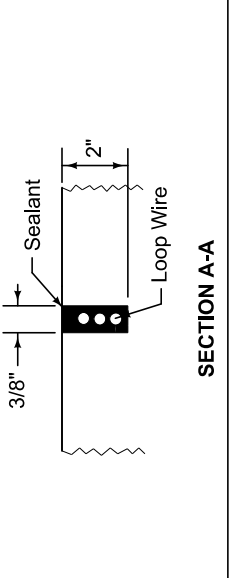
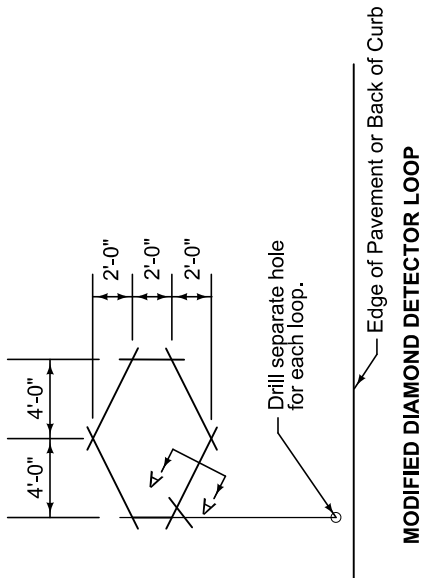

CURB

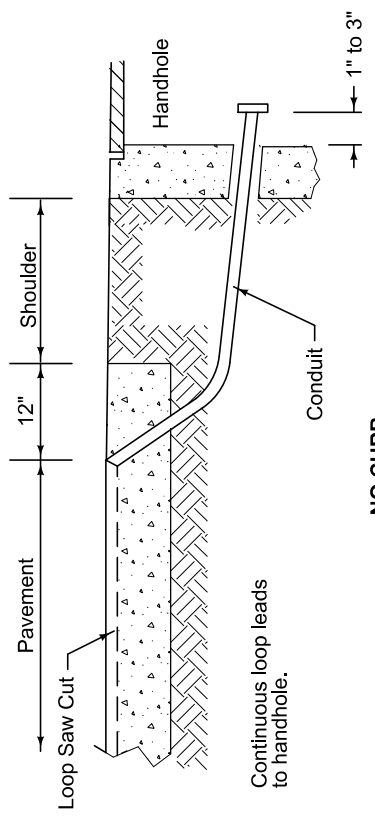

NO CURB

	REVISION New 10-16-12
	8010.104 SHEET 1 of 1
SUDAS Standard Specifications	
INDUCTIVE LOOP VEHICLE DETECTORS	

DETECTOR CONDUIT ENTRY

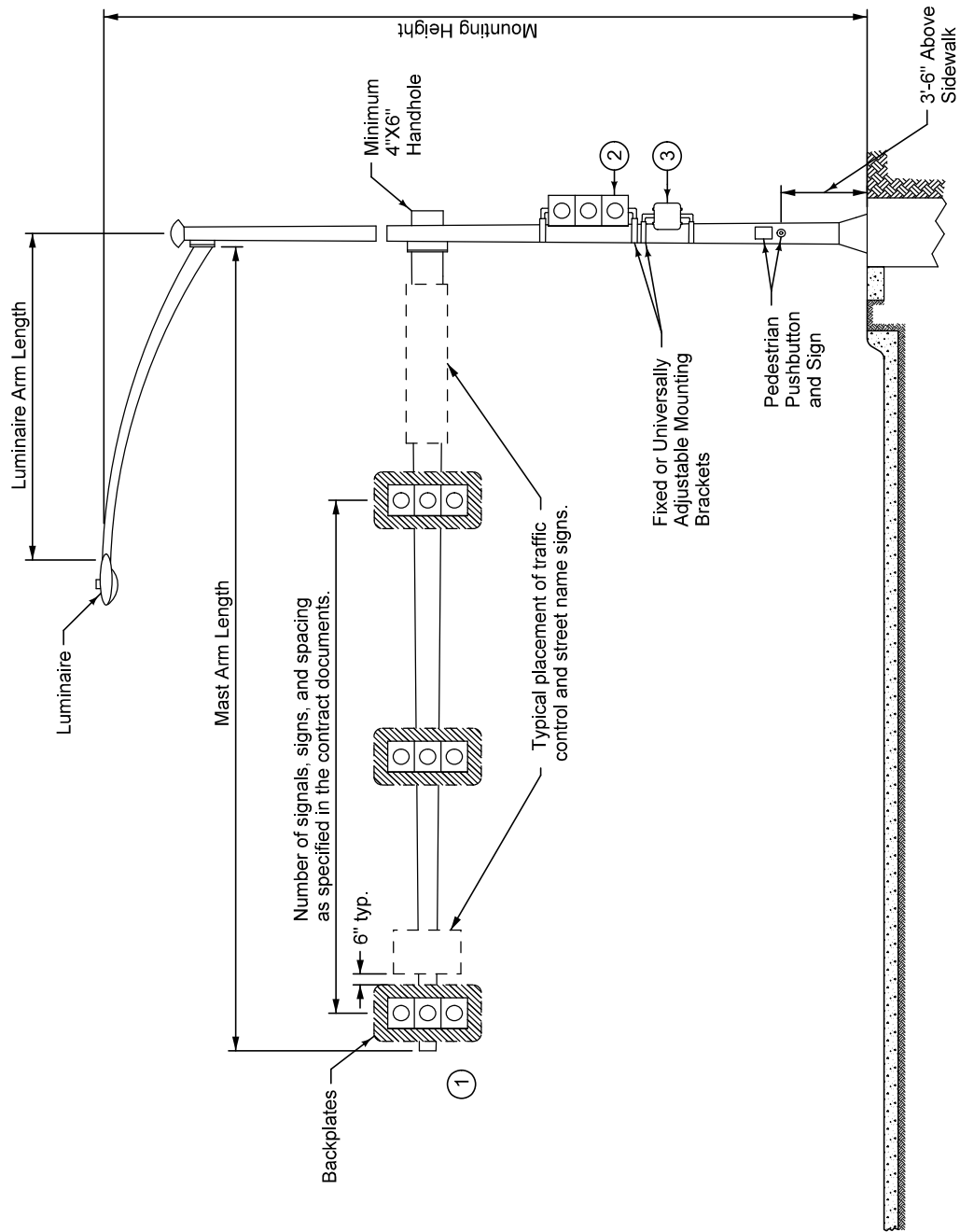

- ① Ensure the top of the signal housing is no more than 25.6 feet above the pavement. Ensure the bottom of the signal housing and related attachments are at least 15 feet above the pavement.
- ② Ensure the bottom of the signal housing (including brackets) that is not located over a roadway is a minimum of 8 feet and a maximum of 19 feet above the sidewalk or, if there is no sidewalk, above the pavement grade at the center of the roadway.
- ③ Mount pedestrian signal heads with the bottom of the signal housing (including brackets) no less than 7 feet or more than 10 feet above the sidewalk level. Position and adjust heads to provide maximum visibility at the beginning of the controlled crosswalk.

	REVISION	New	10-16-12
	8010.105		
SHEET 1 of 1			

SUDAS Standard Specifications

MAST ARM
POLE DETAILS

STEEL MAST ARM POLE

- ① Shape top 11 inches with forms.
- ② Install rodent guard or non-shrink grout with weep hole.
- ③ Provide 1/2 inch diameter hex nut with 1 1/2 inch flat washer. Protect anchor bolt with nut cover.
- ④ Deform threads to prevent nut from backing off.

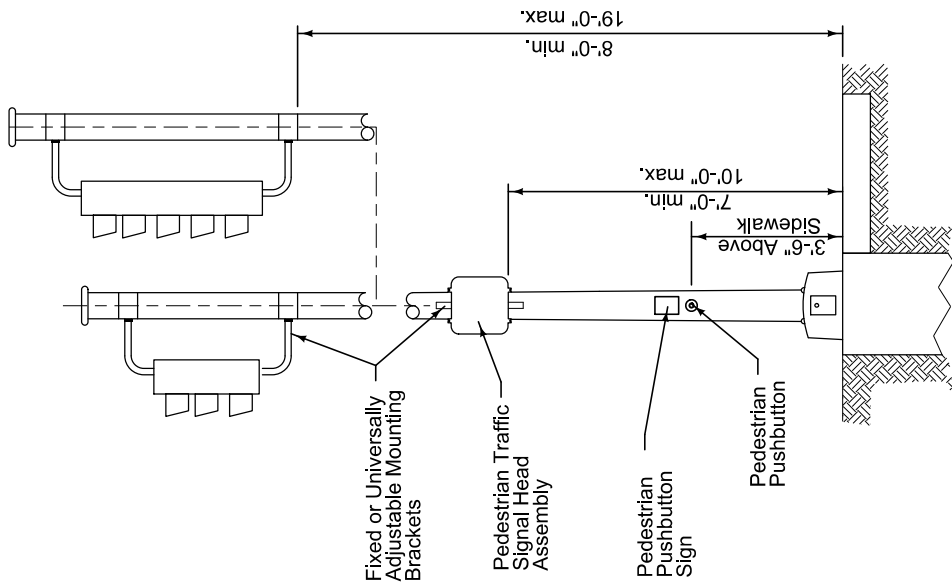
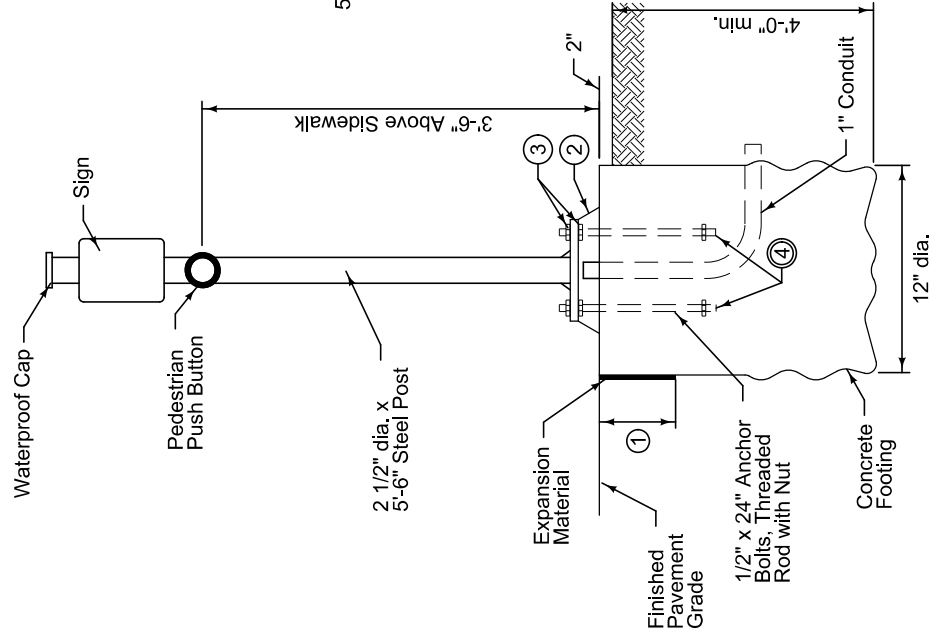
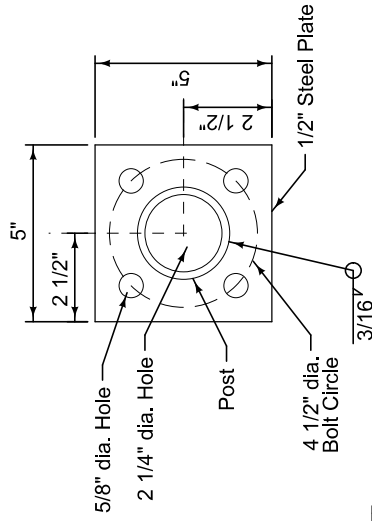

	REVISION	10-16-12
	New	
SUDAS 8010.106		SHEET 1 of 1

SUDAS Standard Specifications

PEDESTAL POLE AND PEDESTRIAN POST DETAILS

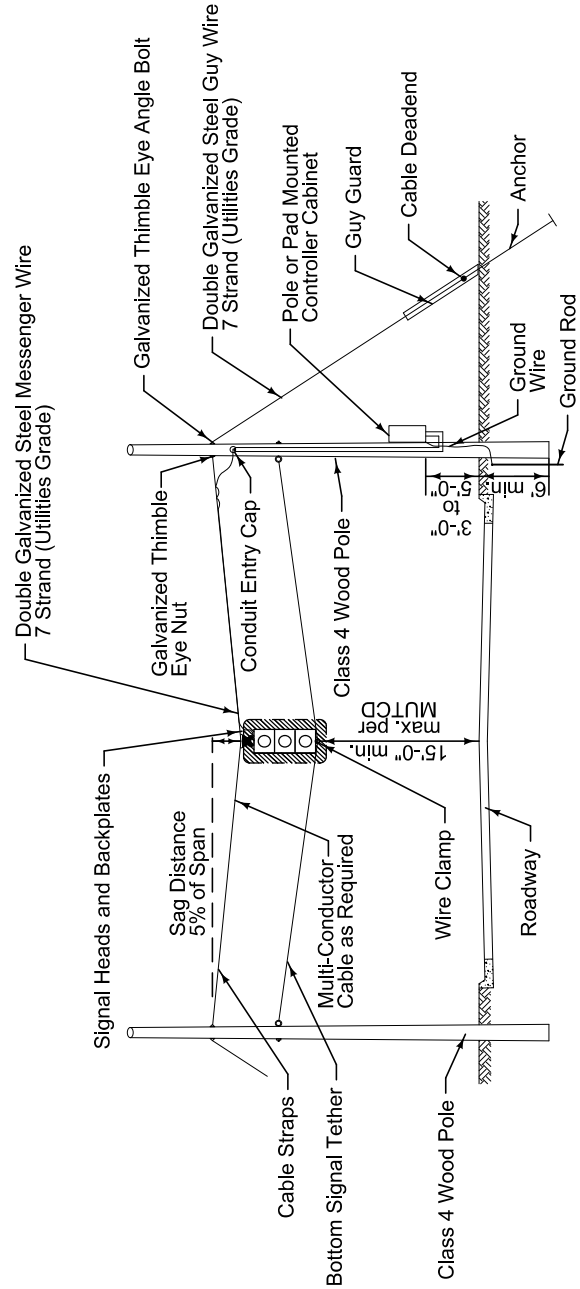

APPENDIX C. MAST ARM POLE FOOTING DESIGN SUMMARY

SHUCK-BRITSON^{INC}

CONSULTING ENGINEERS

2409 Grand Avenue
Des Moines, Iowa 50312-5309
515-243-4477 FAX: 515-243-4479 E-Mail: sarens@shuck-britson.com

SUDAS Mast Arm Pole Footing Summary

SWA 05/08/2012

Pole loadings and anchor bolt layouts were received from both Millerbernd Manufacturing and Valmont Industries for the different mast arm standards. These loads are based on AASHTO Standard Specifications for Structural Supports For Highway Signs, Luminaries, and Traffic Signals, 1994 with a 80 mph wind and a gust factor of 1.3. The controlling loads were used to analyze the footings.

The soil properties controlled the size and depth of the pole footing, as the concrete footing itself had sufficient capacity, when using adequate reinforcing, for the loadings. The soil properties assumed were:

- Poor cohesive soil with an average blow count (N_{60}) equal to or greater than 8. This blow count equates to a compressive strength of $Q_u = 2000$ psf and $c = 1000$ psf. These soil properties match the properties used in the standards from the state of Illinois.
- Groundwater is present.
- For the moment/shear analysis, 2.5' of disturbed soil due to frost was assumed based on engineering judgment. For the torsion analysis, 5' of disturbed soil was assumed based on the current AASHTO Bridge Design Manual.
- Granular soils were originally designed but they were determined to be a special design case based on the larger depths required.

Two different modes of soil failure were analyzed. The footings were not only checked for lateral loading from the moment and shear on the mast arms but also for torsion loading from the arm. The moment and shear creates overturning of the footing, while the torsion creates twisting of the footing.

For the moment/shear analysis, guidelines set forth in AASHTO Standard Specifications for Structural Supports for Highway Signs, Luminaries, and Traffic Signals, 2009 were followed. The Brohm's Method with a safety factor of 2.0 (per discussions with SUDAS) was used to determine the embedment depth required.

For the torsion analysis, guidelines set forth in FHWA-NHI-10-016 Drilled Shafts: Construction Procedures and LRFD Design Methods, May 2010 were followed. The alpha method with a safety factor of 1.0 (matches Florida DOT) was used to determine the embedment depth required.

The larger embedment depth from the two failure modes was used to size the mast arm footing. Reinforcing and ties were then designed based off the footing size.